

Hisense

HYJM-S01H Central Controller

(EN) INSTALLATION AND OPERATION MANUAL

(中文) 安装和操作手册

(RU) Руководство по установке и эксплуатации

(ES) MANUAL DE INSTALACIÓN Y FUNCIONAMIENTO

(TR) Kurulum ve Çalıştırma Kılavuzu

(DE) INSTALLATIONS- UND BETRIEBSHANDBUCH

(IT) MANUALE D'INSTALLAZIONE E D'USO

(NL) INSTALLATIE- EN BEDIENINGSHANDLEIDING

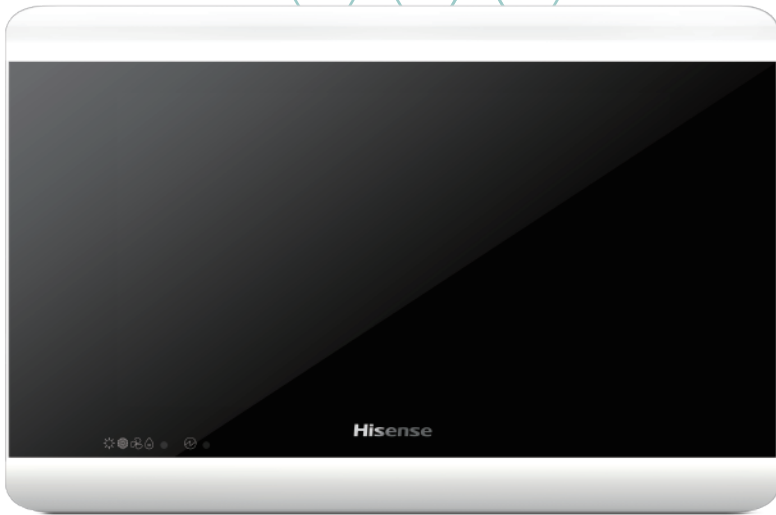



ENGLISH

Specifications in this manual are subject to change without notice in order that Hisense may bring the latest innovations to their customers.

Whilst every effort is made to ensure that all specifications are correct, printing errors are beyond Hisense's control, Hisense cannot be held responsible for these errors.

CAUTION

This product shall not be mixed with general house waste at the end of its life and it shall be retired according to the appropriated local or national regulations in an environmentally correct way.

Due to the refrigerant, oil and other components contained in Air Conditioner, its dismantling must be done by a professional installer according to the applicable regulations.

Contact to the corresponding authorities for more information.



DANGER - Hazards or unsafe practices which could result in severe personal injuries or death.



CAUTION - Hazards or unsafe practices which could result in minor personal injury or product or property damage.



NOTE - The text following this symbol contains information or instructions that may be of use or that require a more thorough explanation.

中文

本手册中的规格如有更改，恕不另行通知，海信将把最新的创新提供给客户。
我们尽量确保所有规格正确，但打印错误可能超出了海信的控制范围，海信对这些错误不负责任。

警告

本产品废弃时不得与一般房屋废物混合，应当按照当地或国家有关规定丢弃。
由于空调中含有制冷剂、油和其他部件，其拆卸必须由专业人员根据适用的规定进行。
联系相关部门了解更多信息。



危险 - 可能导致严重人身伤害或死亡的危险或不安全行为。



警告 - 可能导致轻微人身伤害或产品或财产损失的危险或不安全行为。



注意 - 该符号后面的文字包含可能有用或需要更彻底解释的信息或说明。

Нарусском

Спецификации в данном руководстве могут меняться без уведомления, с тем чтобы Hisense могли донести последние нововведения своим клиентам.

Тогда как прилагаются все усилия для гарантирования правильности спецификаций, печатные ошибки не входят в область контроля Hisense, Hisense не могут нести ответственность за эти ошибки.

ПРЕДУПРЕЖДЕНИЕ

Данный продукт не должен храниться вместе с другими бытовыми отходами по окончании срока эксплуатации и должен быть утилизирован в соответствии с территориальными или национальными нормативами безопасным для окружающей среды путем.

В виду содержания в кондиционере хладагента, масла и других компонентов, разборку устройства должен выполнять профессиональный установщик в соответствии с действующими нормативами.

Для более подробной информации обратитесь в соответствующие инстанции.



ОПАСНОСТЬ - Опасности или небезопасные методы, которые могут привести к серьезным травмам или смерти.



ПРЕДОСТЕРЕЖЕНИЕ - Опасности или небезопасные действия, которые могут привести к незначительной травме или повреждению продукта или имущества.



ПРИМЕЧАНИЕ - Текст, следующий за этим символом, содержит информацию или инструкции, которые могут быть полезны или требуют более подробного разъяснения.

Español

Las especificaciones en este manual están sujetas a cambios sin previo aviso para que Hisense les pueda traer a sus clientes las últimas innovaciones.

Mientras que se realiza cada esfuerzo para garantizar que todas las especificaciones sean correctas, los errores de impresión están ajenos al control de Hisense, Hisense no es responsable por dichos errores.

PRECAUCIÓN

Este producto no debe mezclarse con los desperdicios generales del hogar una vez que el mismo finalizó con su vida útil, debe ser eliminado según las regulaciones nacionales y locales en forma ecológica.

Debido al refrigerante, el aceite y otros componentes contenidos en el aire acondicionado, el desmantelamiento del mismo lo debe realizar un profesional siguiendo las regulaciones aplicables.

Para más información, contacte a las autoridades correspondientes.



PELIGRO- Peligros o prácticas inseguras que pueden resultar en lesiones graves o la muerte.



PRECAUCIÓN - Peligros o prácticas inseguras que podrían resultar en lesiones menores o daños al producto o a la propiedad.



NOTA - El texto seguido de este símbolo contiene información o instrucciones que pueden ser de uso o que requieren de una explicación más completa.

Türkçe

Hisense, müşterilerine en son yenilikleri sunabilmek için bu kılavuzda belirtilen teknik özellikleri bildirimde bulunmaksızın değiştirebilir.

Tüm teknik özelliklerin doğru olması için gayret gösterilmiş olsa da basım hataları Hisense'nin kontrolü dışındadır; Hisense, bu hatalardan sorumlu tutulamaz.

UYARI

Bu ürün, kullanım ömrünün sonunda genel evsel atıklarla karıştırılmamalı ve uygun yerel veya ulusal düzenlemelere göre çevreye uyumlu bir şekilde göre atılmalıdır.

Klimadaki soğutkan, yağ ve diğer bileşenlerden dolayı, söküm işlemi profesyonel biri tarafından geçerli düzenlemelere göre gerçekleştirilmelidir.

Daha fazla bilgi için ilgili yetkililerle irtibata geçin.



TEHLİKE - Ciddi kişisel yaralanmalar veya ölümlerle sonuçlanabilecek tehlikeleri ve güvenli olmayan uygulamaları ifade eder.



DİKKAT - Küçük yaralanmalar veya ürün ya da mal hasarları ile sonuçlanabilecek tehlikeleri ve güvenli olmayan uygulamaları ifade eder.



NOT - Bu işaretten sonra gelen metin, yararlı olabilecek veya daha detaylı açıklama gerektiren bilgi ve talimatları içerir.

Deutsch

Die technischen Daten in diesem Handbuch können ohne vorherige Ankündigung geändert werden, damit Hisense die neuesten Innovationen an ihre Kunden bringen kann.

Wir unternehmen jede Anstrengung, um sicherzustellen, dass alle Spezifikationen korrekt sind. Und die Druckfehler sind außerhalb der Kontrolle von Hisense. Hisense nimmt keine Verantwortung für diese Fehler.

VORSICHT

Dieses Produkt darf nach Ablauf seiner Lebensdauer nicht mit dem allgemeinen Hausmüll gemischt werden, und es wird nach den entsprechenden örtlichen oder nationalen Vorschriften umweltgerecht zurückgezogen.

Wegen des Kältemittels, des Öls und anderer Komponenten, die in der Klimaanlage enthalten sind, muss die Demontage von einem professionellen Installateur gemäß den geltenden Vorschriften durchgeführt werden.

Für weitere Informationen wenden Sie sich bitte an die zuständigen Behörden.



GEFAHR - Gefahren oder unsichere Betriebsweisen, die zu schweren Verletzungen oder zum Tod führen könnten.



VORSICHT - Gefahren oder unsichere Betriebsweisen, welche zu geringfügigen Personen- oder Sachschäden führen könnten.



HINWEIS - Der folgende Text nach diesem Symbol enthält Informationen oder Anweisungen, die von Nutzen sein können oder eine gründlichere Erläuterung erfordern.

Italiano

Le specifiche in questo manuale sono soggette a modifiche senza preavviso affinché Hisense possa apportare le ultime innovazioni per i propri clienti.

Sebbene sia compiuto ogni sforzo per garantire che tutte le specifiche siano corrette, gli errori di stampa sono al di là del controllo di Hisense, che non può essere ritenuta responsabile di questi errori.

ATTENZIONE

Questo prodotto non deve essere miscelato con i rifiuti domestici a fine vita e deve essere smaltito secondo le norme locali o nazionali appropriate in modo ecologicamente corretto.

A causa del refrigerante, dell'olio e di altri componenti contenuti nel condizionatore d'aria, il suo smontaggio deve essere eseguito da un installatore professionale secondo le norme vigenti.

Per ulteriori informazioni, contattare le autorità competenti.



PERICOLO - Pericoli o pratiche non sicure che possono causare lesioni personali gravi o la morte.



AVVERTENZA - Pericoli o pratiche non sicure che possono causare lesioni personali minori oppure danni al prodotto o alla proprietà.



NOTA - Il testo che segue questo simbolo contiene informazioni o istruzioni che possono essere utili o che richiedono una spiegazione più approfondita.

Nederlands

De specificaties in deze bedieningshandleiding kunnen worden gewijzigd zonder voorafgaande kennisgeving opdat Hisense de nieuwste innovaties kan leveren aan haar klanten.

Hoewel alles in het werk wordt gesteld om ervoor te zorgen dat alle specificaties correct zijn, liggen eventuele drukfouten buiten de controle van Hisense; Hisense kan niet aansprakelijk worden gesteld voor dit soort fouten.

LET OP!

Dit product mag niet aan het einde van zijn levensduur worden gemengd met gewoon huishoudelijk afval, en het moet op een milieuvriendelijke manier worden afgevoerd volgens de toegepaste plaatselijke of nationale regelgeving.

Als gevolg van het koelmiddel, olie en andere componenten in de Air Conditioner, moet het demonteren ervan door een professionele installateur volgens de geldende voorschriften worden uitgevoerd.

Neem contact op met de betreffende autoriteiten voor aanvullende informatie.



GEVAAR - Risico's of onveilige praktijken die kunnen leiden tot ernstige persoonlijke verwondingen of de dood.



LET OP! - Risico's of onveilige praktijken die kunnen leiden tot geringe letselschade of product- of eigendomsschade.



OPMERKING - Teksten met dit symbool bevatten informatie of instructies die van nut kunnen zijn, of vereisen een meer grondige uitleg.

INDEX

1. SAFETY SUMMARY	4
2. GENERAL DATA	5
3. PART NAMES AND FUNCTIONS	7
4. INSTALLATION WORK	11
5. TEST RUN PROCEDURE	16
6. OPERATION PROCEDURE	26
7. MENU	36
8. OTHER INDICATIONS ON LCD	49
9. TROUBLESHOOTING	50

目录

1. 安全	51
2. 主要数据	52
3. 各部分名称和功能	54
4. 安装	58
5. 试运转流程	63
6. 操作步骤	73
7. 菜单	83
8. 其它液晶显示	96
9. 故障判断	97

УКАЗАТЕЛЬ

1. КРАТКОЕ ИЗЛОЖЕНИЕ МЕР ПРЕДОСТОРОЖНОСТИ	98
2. ОБЩИЕ ДАННЫЕ	99
3. НАИМЕНОВАНИЯ И ФУНКЦИИ ДЕТАЛЕЙ	101
4. РАБОТЫ ПО УСТАНОВКЕ	105
5. ПОРЯДОК АПРОБИРОВАНИЯ	110
6. ПОРЯДОК ЭКСПЛУАТАЦИИ	120
7. МЕНЮ	130
8. ДРУГИЕ УКАЗАНИЯ ПО ЖК-экрану	143
9. РЕШЕНИЕ ПРОБЛЕМ	144

ÍNDICE

1. RESUMEN DE SEGURIDAD	145
2. DATOS GENERALES	146
3. NOMBRE Y FUNCIONES DE LAS PARTES	148
4. TRABAJO DE INSTALACIÓN	152
5. PROCEDIMIENTO DE LA PRUEBA	157
6. PROCEDIMIENTO OPERATIVO	167
7. MENÚ	177
8. OTRAS INDICACIONES EN EL LCD	190
9. SOLUCIÓN DE PROBLEMAS	191

İÇİNDEKİLER

1. GÜVENLİK ÖZETİ	192
2. GENEL VERİLER	193
3. PARÇA ADLARI VE FONKSİYONLARI	195
4. KURULUM İŞLEMİ	199
5. DENEME PROSEDÜRÜ	204
6. ÇALIŞTIRMA PROSEDÜRÜ	214
7. MENÜ	224
8. LCD EKRANDAKİ DİĞER GÖSTERGELER	237
9. SORUN GİDERME	238

INHALTSVERZEICHNIS

1. SICHERHEITSSUSAMMENFASSUNG	239
2. ALLGEMEINE DATEN	240
3. NAMEN UND FUNKTIONEN DES BAUTEILS	242
4. INSTALLATIONSARBEITEN	246
5. TESTLAUFVERFAHREN	251
6. BETRIEBSVERFAHREN	261
7. MENÜ	271
8. ANDERE ANZEIGEN AUF LCD	284
9. FEHLERBEHEBUNG	285

INDICE

1. SOMMARIO SULLA SICUREZZA	286
2. DATI GENERALI	287
3. NOMI E FUNZIONI DEI COMPONENTI	289
4. OPERAZIONI DI INSTALLAZIONE	293
5. PROCEDURA DI ESECUZIONE DEL TEST	298
6. PROCEDURA DI FUNZIONAMENTO	308
7. MENU	318
8. ALTRE INDICAZIONI SU LCD	331
9. RISOLUZIONE DEI PROBLEMI	332

INDEX

1. SAMENVATTING OMTRENT DE VEILIGHEID	333
2. ALGEMENE GEGEVENS	334
3. NAMEN VAN ONDERDELEN EN FUNCTIES	336
4. INSTALLATIEWERKZAAMHEDEN	340
5. TEST PROCEDURE	345
6. BEDIENINGSPROCEDURE	355
7. MENU	365
8. OVERIGE AANWIJZINGEN OP HET LCD-SCHERM	378
9. PROBLEEMOPLOSSING	379

1 SAFETY SUMMARY

HISENSE cannot anticipate every possible circumstance that might involve a potential hazard.



DANGER

- **DO NOT pour water into the central controller. This product is equipped with electrical parts. If poured, it will cause a serious electrical shock.**
- **DO NOT perform installation work and electrical wiring Connection by yourself. Contact your HISENSE distributor or dealer and ask them for installation work and electrical wiring by service person.**



CAUTION

- **DO NOT install the indoor unit, outdoor unit, central Controller and cable at such places as:**
 - Where there is oil vapor and the oil is dispersed.
 - Where the hot springs are near (in a sulfuric environment).
 - Where generation, flowing, staying or leaking of flammable gas is detected.
 - Where the sea is near (in the salty environment).
 - A place with humid atmosphere or there is possibility of water wetting.
 - A place of poorly ventilated.
 - An acid or alkaline environment.
- **DO NOT install the indoor unit, outdoor unit, central controller and cable within approximately 3 meters from strong electromagnetic wave radiators such as medical equipment. In case that the central controller is installed in a place where there is electromagnetic wave radiation, shield the controller and cables by covering with the steel box and running the cable through the metal conduit tube.**
- **In case that there is electric noise at the power source for the indoor unit, provide a noise filter.**
- **Use specified cables to connect between indoor unit and remote control switch. Selecting incorrect cables may lead to fire or electrical shock.**



NOTE

- **The installer and system specialist shall comply with local regulations or standards for the safety. The following standards may be applicable, if local regulations are not available. International Organization for Standardization, ISO5149 or European Standard, EN378.**
- **Perform electrical work according to the Installation Manual. As for the electrical wiring work and check, turn OFF the main power supply before opening/closing the service cover of indoor unit. If service cover is opened with main power supply left on, it may result in an electrical shock.**
- **This manual should be considered as a permanent part of the air conditioning equipment and should remain with the air conditioning equipment.**
- **This appliance must be used only by adult and capable people, having received the technical information or instructions to handle this appliance properly and safely.**
- **Children should be supervised to ensure that they do not play with the appliance.**
- **Important: read and understand this manual before using this controller.**

If you have any questions, contact your HISENSE distributor or dealer.

2 GENERAL DATA

HYJM-S01H is the central controller for air conditioning system that controls and monitors maximum 160 indoor units.

2.1 MAIN FEATURES

The following functions are available for the all indoor units which are connected to the central controller.

- 1 Run/Stop, Operation Mode Change, Fan Speed Control, Swing Louver Direction Control, ECO mode, Temperature limitation, Temperature Setting and Permitting/Prohibiting Operation by Remote Control Switch.
- 2 Monitoring of Operating Conditions for Block/Groups.
- 3 Schedule Operation (Run/Stop and Temperature Setting) for Block/Groups.
- 4 Run/Stop and Emergency Stop by External Input.
- 5 Run and Alarm Output by External Output.
- 6 Indication and Calculation of Unit Accumulated Operation Time of Each Unit.
- 7 Indication of Alarm History Record.
- 8 Registering Name of Blocks and Groups.
- 9 Registration and Indication of Service Contact Information.

NOTE

- **Group:** Remote Control Group
- **Block:** Collective of Remote Control Groups

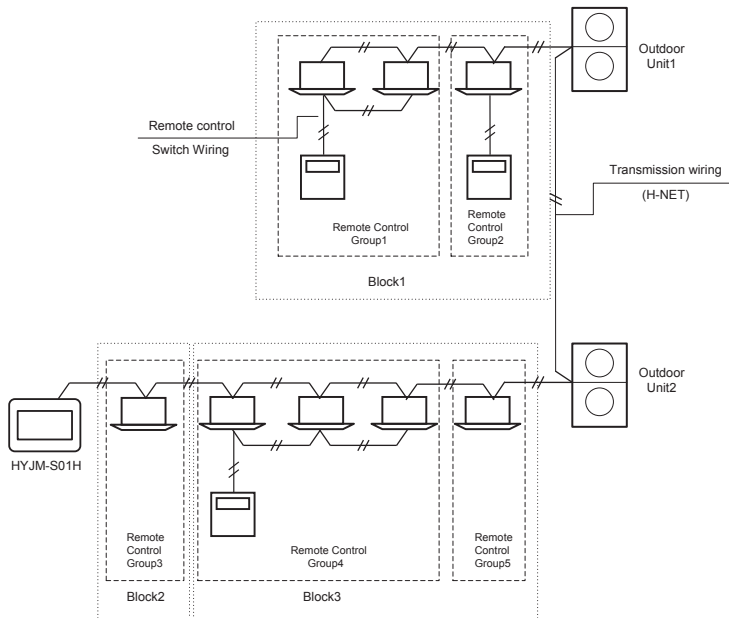

2.2 DIMENSIONAL DATA

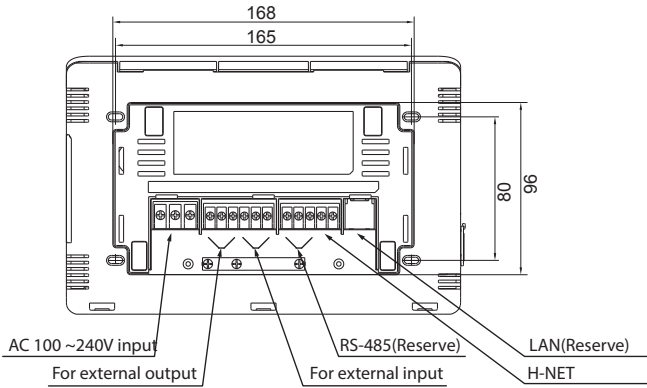
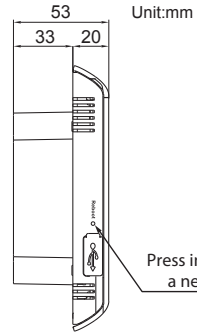
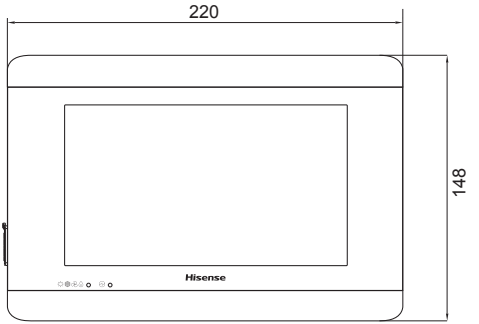

2.3 SPECIFICATION

Model	HYJM-S01H
Outer Dimension <W x H x D + (Built-in Part)>	220x148x20+33(mm)
Net Weight	0.68Kg(Approx.)
Installation Location	Indoor
Installation Method	Wall Built-in or Wall Surface Mounting
Connected Indoor Unit (Qty)	160 (Max.)
Clock Accuracy	± 70 Seconds/Month (at Normal Temperature)
Ambient temperature	5~35 °C
Ambient Humidity	35~90% (No Dew Condensation)
Display	7" TFT Color Liquid Crystal Display (1024 x 600 dots)
Rated Power Supply	1Φ, AC 100 ~240V, 50/60Hz
Electrical Power Consumption	13.5W (Max.)

3 PART NAMES AND FUNCTIONS

▪ Front Side

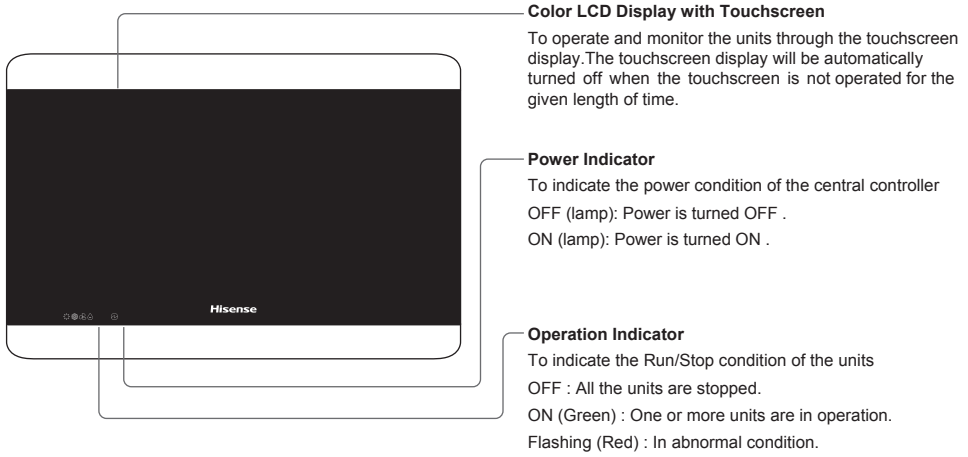

i NOTE

Remove the protection sheet on LCD (liquid crystal display) before using this product.

▪ Right Side

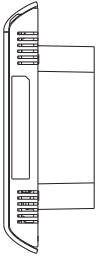

▪ Rear Side

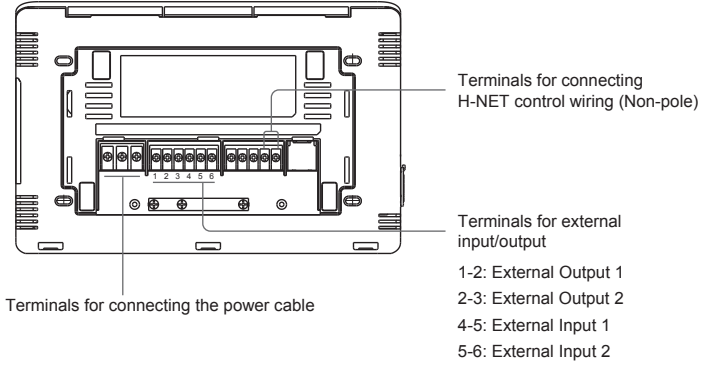

When Unit Body is opened

SP1

For terminating resistance
It is used for transmission line recovery.

Fuse for H-NET Transmission Line

For protection of H-NET transmission line

Fuse for Power Supply

For protection of power circuit

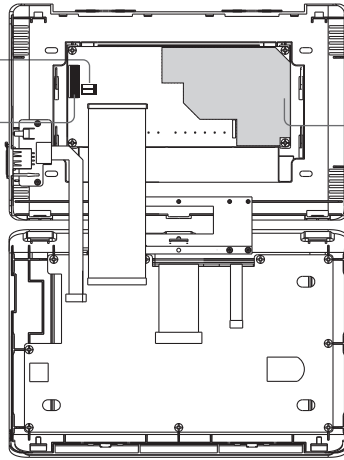

DO NOT remove the covers of marked with “” for safety. If remove these and touch inside, it may cause a serious electrical shock.

3.1 SCREEN DISPLAY

3.1.1 “AC Monitor(All Groups)”

Present Indication
To display the present indication (all groups)

AC Monitor (All Groups) 02-10-2017 10:20

	1st Meeting Room	2nd Meeting Room	3rd Meeting Room	4th Meeting Room	5th Meeting Room	6th Meeting Room	7th Meeting Room	8th Meeting Room
East Office	1st Office Room	2nd Office Room	3rd Office Room	4th Office Room	5th Office Room	6th Office Room	7th Office Room	
	Group2-1	Group2-2	Group2-3	Group2-4	Group2-5	Group2-6	Group2-7	Group2-8
South Office	Group2-9	Group2-10	Group2-11	Group2-12				
	Group3-1	Group3-2	Group3-3	Group3-4	Group3-5	Group3-6	Group3-7	Group3-8
West Office	Group3-9	Group3-10	Group3-11	Group3-12	Group3-13	Group3-14	Group3-15	Group3-16
	Group4-1	Group4-2	Group4-3	Group4-4	Group4-5	Group4-6	Group4-7	Group4-8
North office	Group4-9	Group4-10	Group4-11	Group4-12	Group4-13	Group4-14	Group4-15	

Menu
 Alarm Info
 All Groups Setting
 All Groups Run
 All Groups Stop
 All Groups ECO

Block Button

To change the screen display into “Block” AC Monitor (Block) indication by touching this button.

Group Button

To indicate the operating condition of each group as follows:

- Green : Run
- Gray : Stop
- Red : Abnormal

If the target group button is touched, “Settings” of the target group screen will be indicated. (Refer to Run/Stop for each group section)

“All Groups Stop” Button

To stop all the units simultaneously which are controlled by the central controller.

“All Groups Run” Button

To run all the units simultaneously which are controlled by the central controller.

“All Groups Setting” Button

To change the setting of the units simultaneously which are controlled by the central controller.

“All Groups ECO” Button

To start ECO mode of the units simultaneously which are controlled by the central controller.

“Menu” Button

To indicate the menu items such as “Filter Sign Reset”, “Schedule Setting”, etc.

“Alarm Info.” Button

To indicate the abnormality Tap the button for details.

3.1.2 “AC Monitor(Block)”

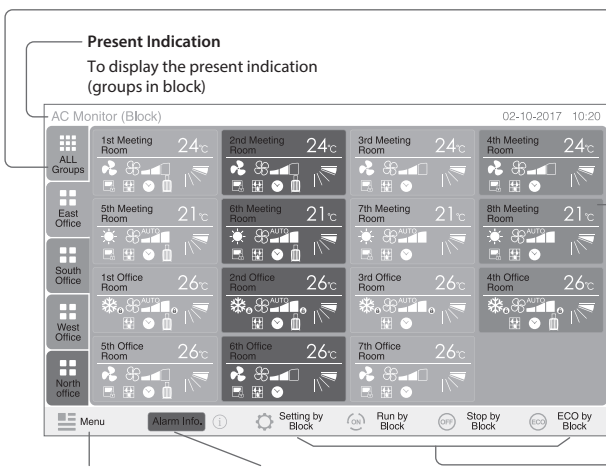

Present Indication

To display the present indication (groups in block)

Block Tab

To change the monitor display into “Block” or “All Groups” indication.

Group Button

To indicate the operating condition

- Green: Run
- Gray: Stop
- Red: Abnormal

If the target group button is touched, “Settings” of the target group screen will be indicated.

“Stop by Block” Button

To stop the all groups operation in the target block simultaneously.

“Run by Block” Button

To run the all groups operation in the target block simultaneously.

“Setting by Block” Button

To change the setting of the all groups in the target block simultaneously.

“ECO by Block” Button

To start ECO mode of the all groups in the target block simultaneously.

“Menu” Button

To indicate the menu items such as “Filter Sign Reset”, “Schedule Setting”, etc.

“Alarm Info.” Button

To indicate the abnormality Tap the button for details.

3.2 DISPLAY OF SERVICE MENU SCREEN

- 1 Touch “Menu” on screen of AC Monitor(All Groups) or AC Monitor (Block) at least 5 seconds. “Service Menu” is displayed.

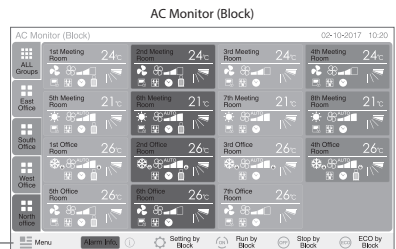
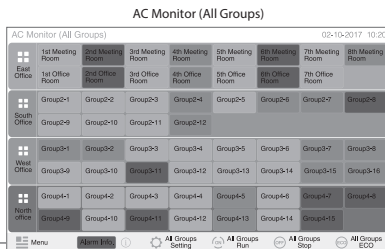

(1)

(1)

- 2 Select the service menu item by touching each item button. The setting screen of touched item will be displayed.

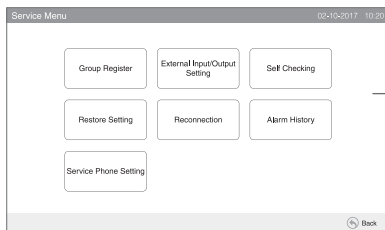

(2)

NOTE

Following items are available only when none of the air conditioners (connected to the central controller) is being operated.

*** External Input/Output Setting**

Stop the operation of all indoor units when selecting the items above.

3.3 EXIT SERVICE MENU SCREEN

Touch "Back" on "Service Menu" to return to AC Monitor (All Groups) or AC Monitor (Block).

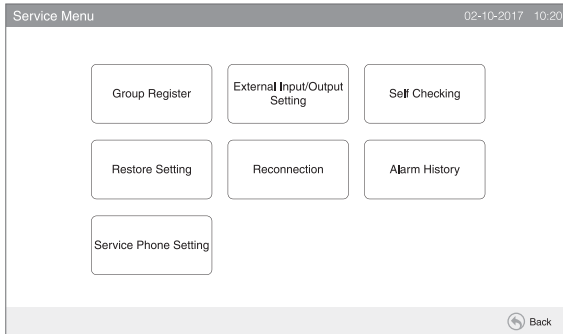

3.4 QUICK REFERENCE

The table below shows the display on the screen and its function structure.

Screen Display		Function
AC Monitor (All Groups)		To display the name of all groups and operating conditions.
AC Monitor (Block)		To display the name of groups in the block and operating conditions.
Menu		To display the list of menu items.
Filter Sign Reset		To reset the filter sign.
Schedule Setting	Schedule Timer Setting	To set or change the weekly schedule.
		To copy the schedule setting.
		To delete the schedule timer setting.
	Holiday Setting	To specify days of suspended schedule setting.
Schedule Timer ON/OFF Setting		To set schedule operation ON/OFF.
Date & Time		To adjust the date and time.
Touchscreen Cleaning		To lock the touchscreen for cleaning.
		To register the name of block and group.
		To copy the name of block and group.
Screen Display Setting	Brightness	To adjust the backlight brightness of display screen.
	Temperature Unit	To set the temperature unit.
Accumulated Operation Time		To display the accumulated operation time of the unit.
Contact Information		To display the service contact.
Language Setting		To set the displayed language.
ECO Setting		To set the temperature and fan speed of ECO mode.

3.5 FUNCTIONS

The table below shows the main functions.

Operation Procedure	Menu Function
Display of All Groups (All the indoor central controllers.)	Menu(Menu Items and Details)
Display of Specified Block (All the remote control groups in the block which are connected to the central controller.)	Filter Sign Reset
Simultaneous Run/Stop for All Group	Schedule Operation
Simultaneous Run/Stop for Block	Adjusting Date/Time
Run/Stop for Each Group	Touchscreen Cleaning
Operation Mode Change	Registering Groups/Blocks Name
Fan Speed Setting	Screen Display Setting
Swing Louver Direction	Accumulated Operation Time of Unit
Setting Temperature	Contact Information
Permitting/Prohibiting Operation from Remote Control Switch	Language Setting
Start ECO/Set Temperature Limitation	ECO Setting

4 INSTALLATION WORK

4.1 SELECTION OF INSTALLATION PLACE









Select a suitable place for handling and determine the installation place of the central controller with the customer's acceptance. Do not install the central controller at such places as:

- Where children can touch.
- Where the air from the air conditioner is directly discharged.

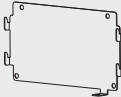
Prior to the installation work, ensure that foundation is flat, level and sufficiently strong and then fix the unit securely. If the foundation is not strong enough, it may lead to injuries caused by falling of the product, electrical shock or fire.

4.2 BEFORE INSTALLATION

When unpacking central controller HYJM-S01H, check that it has not suffered damage during transport. Check to ensure that the following parts are packed with the central controller.

Item	Central Controller HYJM-S01H	Installation and Operations Manual	Wall Mounting Metal Plate	Screw
Appearance				 M3x 20mm
Q'ty	1	1	1	4
Item	Screw	Plastic Expansion Bolt	Battery	Magnetic Ring
Appearance	 M3.5x 25mm			
Q'ty	4	4	1	1

4.3 SYSTEM CONFIGURATION

This central controller (HYJM-S01H) is connected to H-NET and used for the central control and monitoring of the air conditioners. The system configuration example is shown in below.

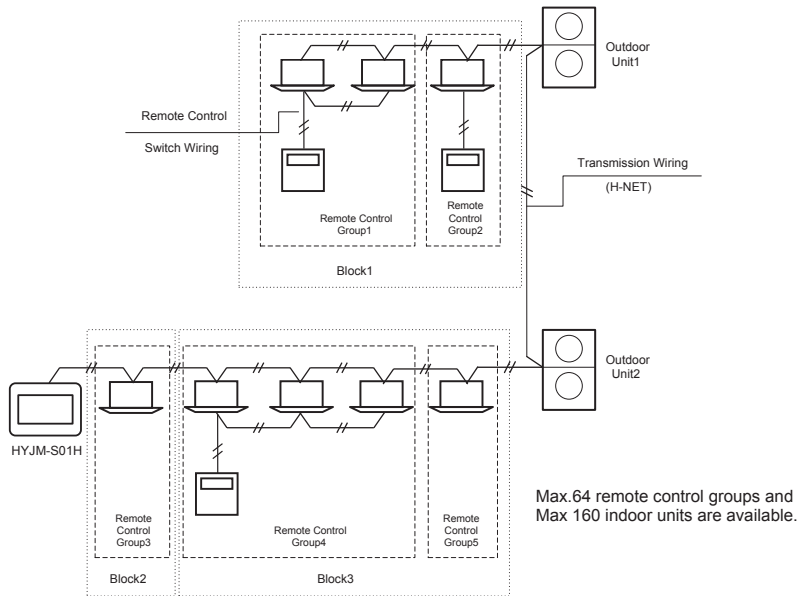

4.4 INSTALLATION PROCEDURE

The installation procedure shall be performed as shown below.

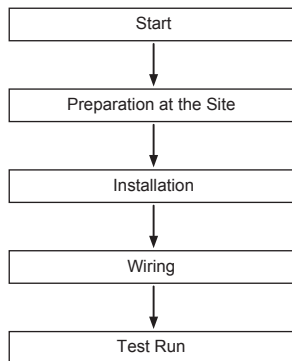

4.4.1 Preparation at the site

Before installing a controller, prepare the following items.

Parts	Specification
Switch Box	Switch Box for 7" touchscreen(non-essential for Wall Surface Mounting)
Power Supply Cable	Cable SPEC: 0.75 mm ² Recommended Cable: 600V CV, CCV, CEV
H-NET Cable (For Control)	Cable SPEC: 0.75 mm ² Recommended Cable: Twist Pair Cable with Shield, Over 0.75 mm ²

4.4.2 Installation space

Keep the installation space for the central controller as shown below.

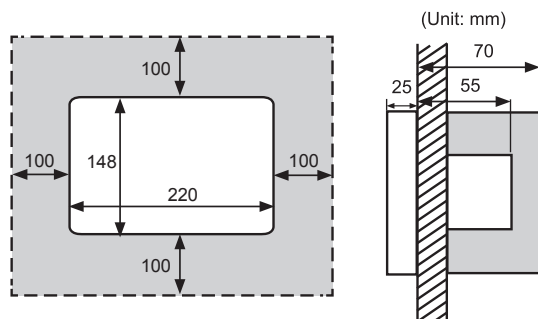

Do not attach anything in the half-tone screen area . When installing central controller near other devices in row or in line, keep the space between each.
 * Vertical Direction: 100mm
 * Horizontal Direction: 100mm

4.4.3 Installation method

Wall Built-in:

1. Install the switch box into the wall.
2. Take off the rack as shown.

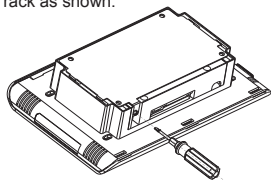

3. Open the terminal cover, and connect the wiring to the terminal of controller.
 - a. The power cable is wound around the magnet ring 3 times and finally the cable and magnet ring are fixed with tie band.
 - b. The external input and output signal wires are respectively connected to the corresponding terminals.

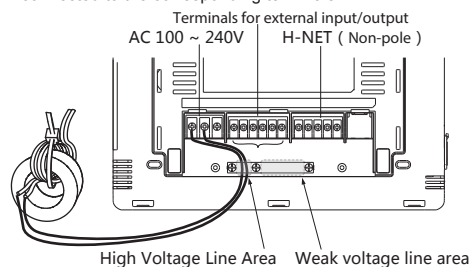

4. When the connection is finished, the strong and weak wires are separated by a press plate and fixed as illustrated.
5. Cover the rear cover and fix the cover with 2 screws (M3x 6mm).
6. Open the unit body as shown below.
 - a. Open the top cover of unit body.
 - b. While pressing the convex part (2 portions), pull the top case and the controller opened.

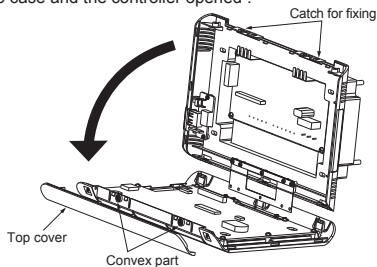

7. Fix the switch box by accessory fixing screw (M3 x 20mm).

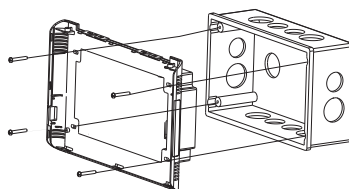

8. Install the battery as shown.

9. Close the unit body until hearing snapping sound, and make sure if the top and bottom close fully. At this time, check if the top side cover is fixed and closed firmly.



NOTE

The life cycle of battery is 1-2 years. Please change the battery after running out.

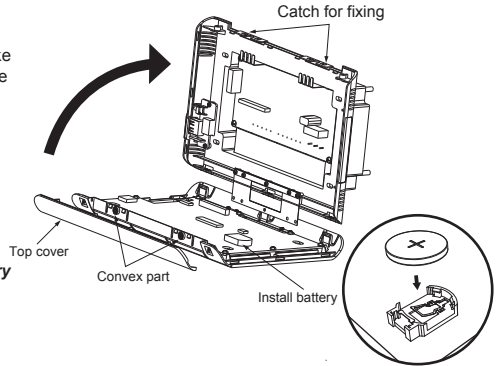

Wall Surface Mounting:

1. Take off the rack as shown.

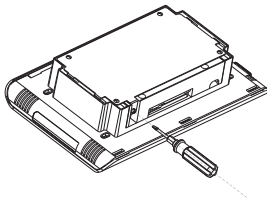

2. Open the terminal cover, and connect the wiring to the terminal of controller.

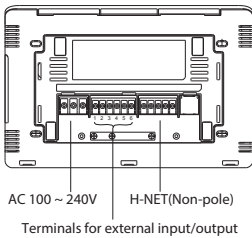

3. When the connection is finished, the wires shall be fixed with a press plate.
4. Cover the rear cover and fix the cover with 2 screws (M3x6mm).
5. Install the battery. (The installation method as above).
6. Close the terminal cover. Fix the rack by accessory fixing screw (M3.5 x 25mm).

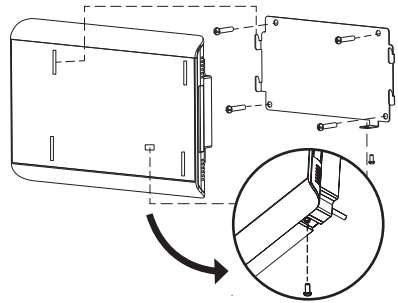

7. Hang the controller on the rack. Fix the controller by accessory fixing screw (M3 x 6mm).

Switch setting:

Control Board Coding Switch SC1	Power Board Coding Switch SP1	Communication Board Coding Switch S1
<p>Factory defaults: 1 OFF 2 OFF 3 ON 4 ON 5 ON</p>	<p>Factory defaults: 1 OFF 2 OFF</p> <p>1 ON After the fuse failure though the code shield can continue to use</p> <p>2 ON Connect the terminating resistor and capacity to the H-NET communication line</p>	<p>Factory defaults: 1 ON 2 OFF</p>
Control Board Coding Switch SC2	Power Board Coding Switch SP2	Communication Board Coding Switch S2
<p>Factory defaults: 1 OFF 2 ON</p>	<p>Factory defaults: 1 OFF 2 OFF</p> <p>1 ON 2 ON Connect the terminating resistor to the RS485 communication line</p>	<p>Factory defaults: 1 OFF 2 OFF</p>

4.5 ELECTRICAL WIRING

- 1.This central controller (HYJM-S01H) requires wiring work of the power supply cable,air conditioner,and control wiring(H-NET).
- 2.Wiring Method.

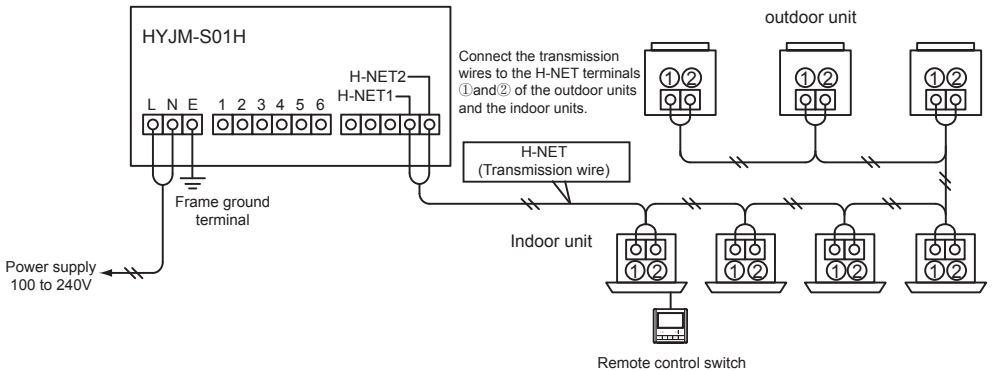

Type of wiring	Specification	Length of	Cable	Recommended cable
Power supply cable	AC100~240V		0.75 mm ²	
Earth wiring			0.75 mm ²	
H-NET (Control Wire)	DC5V	<1000m	0.75 mm ²	Twist pair cable with shield
Wiring for external input and output	Input: Non-voltage normal open Output:DC 12V,75mA		0.75 mm ²	

NOTE

- The central controller may break down by an incorrect wiring.
- The transmission wires are required to be separated from the power supply wiring and other electrical device wiring. Keep at least 30cm between transmission wiring and the power supply wiring. If the above is not secured, put the power supply wirings and transmission wirings into each metal conduit tube separately. The one side of the metal conduit tubes should be earthed for noise reduction.
- Do not connect the power supply wiring to the terminals for transmission. However, if the power supply wires are connected incorrectly, the fuse of the printed circuit board will blow out for protection. In this case, turn on the SP1 pin on the printed circuit board for unfused emergency operation.
- Remove the earth wiring of “E” terminal securely when the insulating capacity test or the withstand voltage test is performed. If the above is not secured, it may cause of breaking down of the central controller.

Main breaker switch

Model	Supply voltage	Maximum current (A)	ELB(1)		CB(2)
			Rated current (A)	Sensitivity (mA)	Rated current
HYJM-S01H	100~240 V 50/60 Hz	5	40	30	5

* (1) ELB: earth leakage breaker (field-supplied) (2) CB: circuit breaker (field-supplied)

CAUTION

On using AC200V to 240V for power supply.

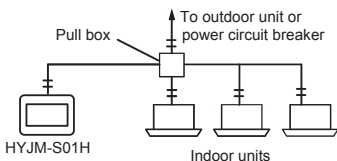

- In the case of power supply voltage is 200V to 240V, diverge the main power supply cables by using the pull box as shown in the figure. (As for the power cables between the indoor units, refer to the technical catalog, etc.).
- The electricity supply to the unit should be via an exclusive power control switch and protective circuit breaker, certified and installed in accordance with local or national safety regulations.

Use an earth leakage breaker with medium sensitivity, and an activation speed of 0.1 or less. If this is not fitted, there is a risk of electric shock and/or fire.

Install an earth leakage breaker, fuse and circuit breaker for each outdoor unit power line. Not fitting it may cause an electric shock or fire.



DANGER

- Turn OFF the main power switch for the indoor units, outdoor units, and central controller before the electrical wiring work is performed. If not, it may cause a fire, electrical shock or device breaking down.
- Do not use cables that are lighter than the normal flexible coated polychloroprene cable.

5 TEST RUN PROCEDURE

The outline of the test run procedure is indicated as shown in the figure. The marked of "" are required items.

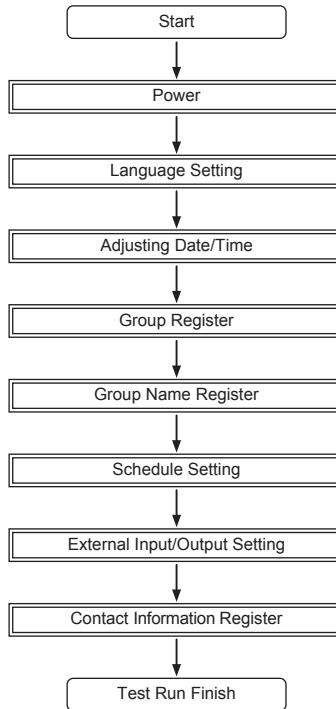

5.1 LIST OF ITEMS

Item	Function
Language Setting	This function is used for language selection.
Date&Time	This function is used for adjusting the date and time.
Group Register	The connected indoor units are checked by the central controller in the same H-NET. This function is used for the group or block registration of them.
Name Register	This function is used for registering name of the block and group. The registrable number of letters are maximum 2 letters for the name of each block or group. It is also available to copy the name. If the group/block is registered without name, it will be registered as "Group 1-1" or "Block 1" automatically.
Schedule Setting	This function is used for scheduled timer operation which is possible to set by each group or block.
Schedule Timer Setting	This function is used for setting the time (by the minute), "Run/Stop" and temperature (19°C~30°C). For weekly schedule setting, up to 10 schedule items can be set per day. It is also available to copy the setting.
Holiday Setting	This function is used for suspending the schedule operation temporarily. The schedule operation will not be available when this function is set. This function is used for setting irregular holidays such as national holidays.
Schedule Timer ON/OFF Setting	"Schedule Timer OFF Setting" is used for suspending the schedule operation for the target group. The schedule operation will not be available when Schedule Timer is OFF. This function is used for a long holiday.
External Input/Output Setting	Two (2) external input terminals and two (2) external output terminals are equipped in the central controller. These terminals are used for "All Groups Run/Stop" and "Emergency Stop" operations for the connected air conditioners. The external output terminals are used for the operation signal output or alarm signal output of the air conditioners which is connected to the central controller.
Contact Information Register	This function is used for editing the contents of contact information registration.
Restore Setting	This function is used for restoring all the settings such as registered Groups (Blocks) and schedules.
Reconnection	This function is used for checking of the connected indoor unit numbers in the same H-NET.
Alarm History	This function is used for displaying the list of alarm history that occurred in the air conditioner and the controller. (Maximum 160 records)

5.2 INITIAL POWER ACTIVATION SETTING

Supply power to the Unit

Turn on the power supply of the air conditioners.
Perform after checking of each air conditioner has test run and confirming all the air conditioners operates normally.
Turn on the power supply of the central controller.
"Loading" will be displayed for a while and the screen changes to AC Monitor.

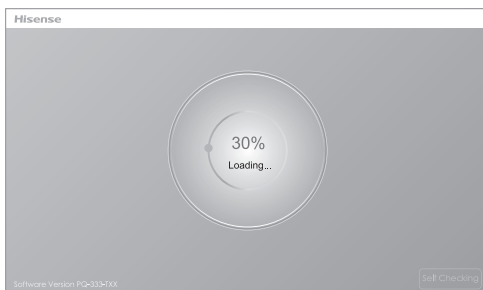

5.3 LANGUAGE SETTING

Several minutes later after turning ON the power supply, the language setting screen is displayed on the touchscreen as shown in the figure.

(When the power supply is turned ON at the first time.)

Select the using language for operation and touch "OK".

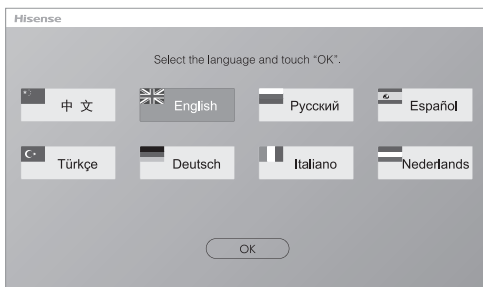

5.4 SET DATE&TIME

After language setting, the setting date & time screen is displayed on the touchscreen as shown in the figure. (When the power supply is turned ON at the first time.)

After setting the date and time, touch "OK" on the touchscreen display.

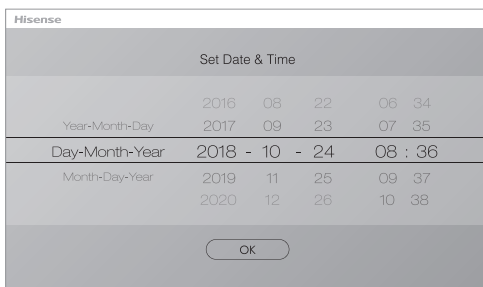

5.5 GROUP REGISTER

Register the indoor units confirmed for connection to the group (block) of the central controller. Confirm the number of the units. (When the power supply is turned ON at the first time.)

Touch "Yes" on the touchscreen and the setting screen is displayed.

Touch "No" on the touchscreen, the controller will connect to the units again.

The registrable number of letters are maximum 20 for the name of the group (block).

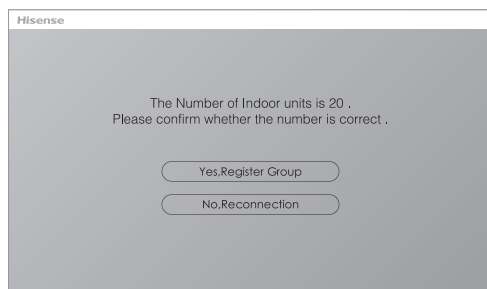

Group and Block

- *Group (Remote Control Switch Group):*

Group is the minimum operation unit from the central controller. Multiple indoor units (Max. 16 units) connected by the transmission wiring is a group. The indoor unit without remote is also a group. The indoor unit in the same group are controlled the same operation. Maximum of 64 groups (4 blocks x 16 groups) can be controlled by one central controller.

- *Block:*

Operation unit of the groups. Maximum of 16 groups can be registered within one (1) block. Maximum of 4 blocks can be controlled by one central controller.

- *Main Unit:*

The main unit registration is available for the only one indoor unit per one group. The control command is sent from the central controller to the main unit for the group.

- *Sub Unit:*

The indoor unit that except the main unit in the same group. They are controlled by the same operation with the main unit.

Unit Registration

- The unit registration is available for the only one main indoor unit per one group. Thus, duplicate registration of the main unit is not possible into the same group.
- The units without remote control switch, one indoor unit equals one group.

5.5.1 GROUP REGISTER

1. Select "Group Register" on the screen of "Service Menu".

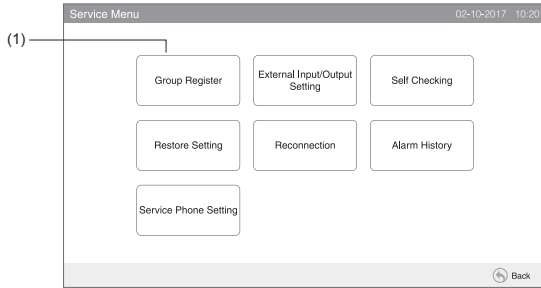

NOTE

This function cannot be selected when the external input signal is input to the external input terminal 1 or 2.

1. Select group for unit to register.
 - When touching "<" or ">" on the upper left of the touchscreen, the block display is switched.
 - The information of Block No and Group No are indicated in the button as "Block Number - Group Number".
 - Select the group button by touching. The selected button is marked. If the selected group button is touching again, the group selection will be canceled.

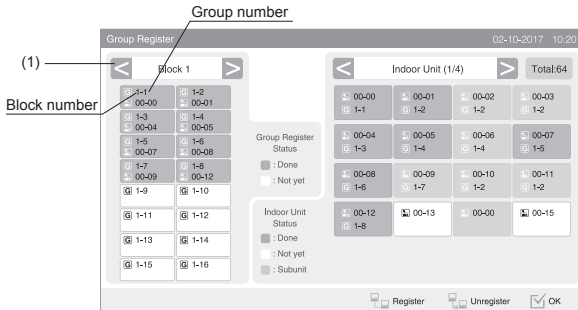

2. Select the indoor unit for register.
 - Tap "<" or ">" on the upper right of the touchscreen, the display of indoor units is switched.
 - The information of the refrigerant cycle No. and indoor unit address are indicated in the indoor unit button as "Refrigerant Cycle No-Indoor Unit Address".
 - Select the indoor unit button by touching. The selected button is marked. If the selected button is touching again, the indoor unit selection is canceled.
 - Sub unit can be registered automatically with its main unit.
3. Touch "Register" to register the unit while the group and indoor unit are selected.
 - The information is indicated in the buttons as below.

- "Group" Button

- "Indoor Unit" Button

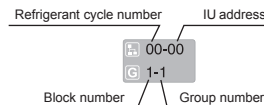
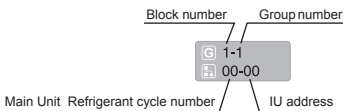

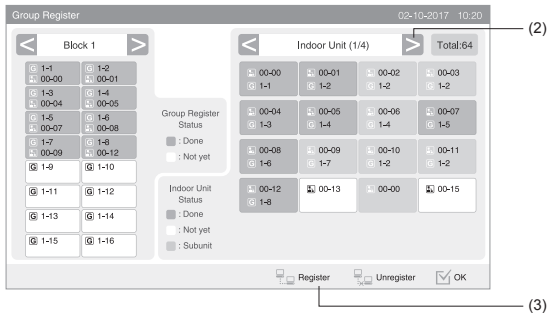

4. Touch "OK" on "Group Register" to return the screen of "Service Menu".

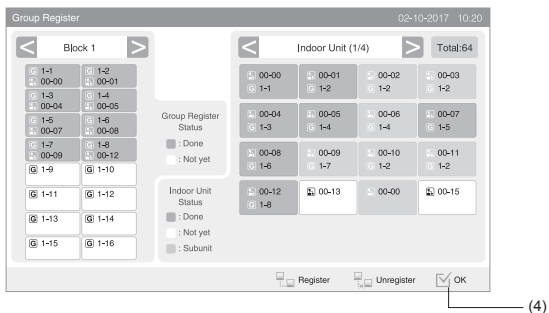

5.5.2 How to unregister group

1. Select "Group Register" on the screen of "Service Menu". Refer to item How to register group.

i NOTE

This function cannot be selected when the external input signal is input to the external input terminal 1 or 2.

2. Select group to unregister.

- When touching "<" or ">" on the upper left of the touchscreen, the block display is switched.
- Select the group button by touching. The selected button is marked. If the selected group button is touching again, the group selection will be canceled.

3. Touching "Unregister" and group register is unregistered. The button color of the group and the indoor unit turn to white.

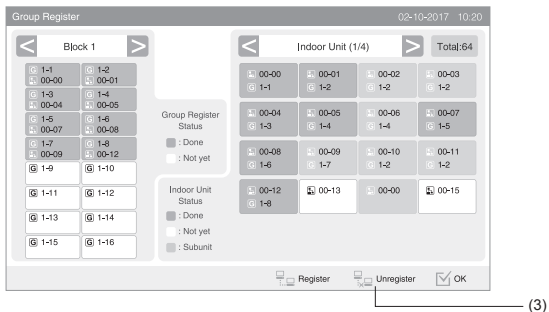

4. Touch "OK" to return to screen of "Service Menu".

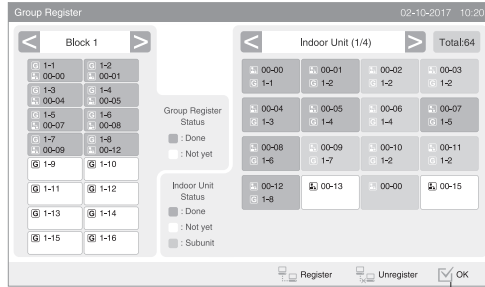

(4)

5.6 SCHEDULE OPERATION

This function is used for the timer operation. The schedule setting is possible to set for the block and each group. Holiday setting that does not activate the schedule is also available. Refer to the chapter Schedule Operation for details.

5.7 EXTERNAL INPUT/OUTPUT SETTING

The external input/output each of two terminals are available. The assigned functions are shown in below.

Input and Output	Function
Input 1	All Run/Stop (Level) (Input 1 Factory Setting) Emergency Stop (Level) (Input 2 Factory Setting)
Input 2	All Run (Pulse) All Stop (Pulse) No Setting
Output 1	All Run (Output 1 Factory Setting) Alarm(Output 2 Factory Setting)
Output 2	No Setting

External Input Function

1 All Run/Stop (Level)

All groups simultaneously Run/Stop operation by the external input signal

2 All Run (Pulse)

All groups simultaneously Run operation by the external pulse input signal

3 All Stop (Pulse)

All groups simultaneously Stop operation by the external pulse signal input

4 Emergency Stop (Level)

All groups simultaneously Stop operating on receiving an external emergency stop signal. While an "Emergency Stop" is performed, the LCD of the remote control switch displays "Central Control" and the operation cannot be changed from the remote control switch.

External Output Function

1 All Run Output

External output for indoor unit operation signal in the target group.

2 External Output Alarm

External output alarm signal for indoor unit in the target group. The alarm signal outputs even if one indoor unit abnormality occurs in the target group.

External Input/Output Terminals Specification

Input Terminal:

Non-voltage contact (normal open) for signal Input DC12V, 10mA. The switching of the contact is available.

Pulse width is 100ms or more for pulse signal input.

Output Terminal:

Contact (voltage is applied) for signal Output DC12V.

- 1 Select "External Input/Output Setting" on the screen of "Service Menu".

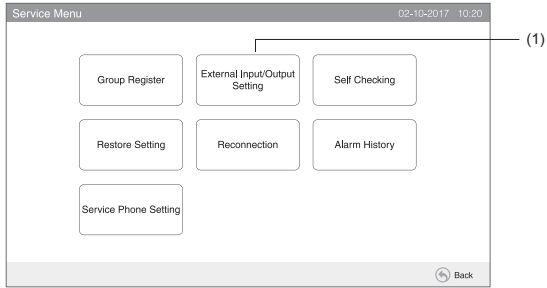

NOTE

This function cannot be selected when the air conditioner(s) is operated or the external input signal is input to the external input terminal 1 or 2.

- 2 Select the function by touching the button for each external input/output terminal as follows: "Input 1", "Input 2", "Output 1" and "Output 2".

The selected function button color is changed.

- 3 Touch "OK" to finish this setting. The screen is returned to "Service Menu".

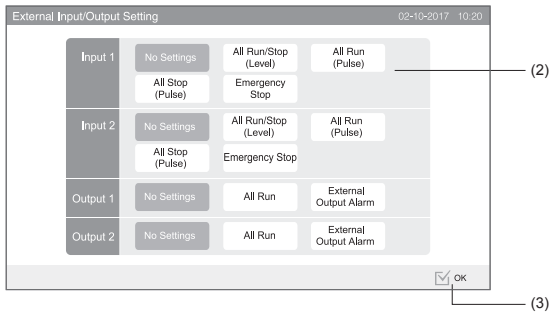

5.8 CONTACT INFORMATION REGISTER

The contact information editing or registering for "Contact Info. Register" indication function.

- 1 Select "Service Phone Setting" on the screen of "Service Menu".

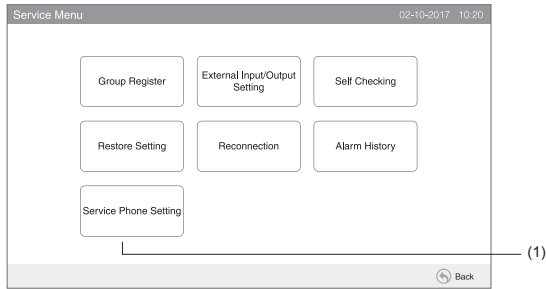

- 2 Select "Contact Info. 1 Name Editing" or "Contact Info. 1 TEL. No. Editing" to register the information.
- 3 Select the characters to input from the keyboard.

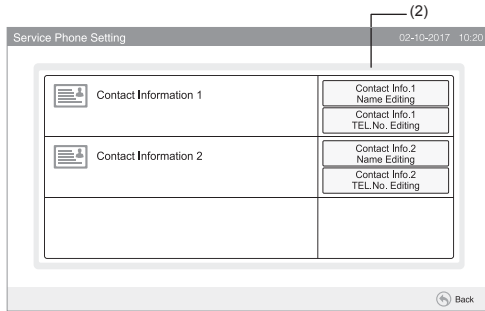

- 4 Input the information. Max. 20 characters are available to input.
- 5 Touch "OK" to finish. The screen is returned to "Service Phone Setting".
- 6 Proceed to register the contact information depending on the setting afterwards.
 - Continue to register or edit the contact information. (2)
 - Finish this setting. (7)
- 7 Touch ""Back" to finish this setting. The screen is returned to "Service Menu".

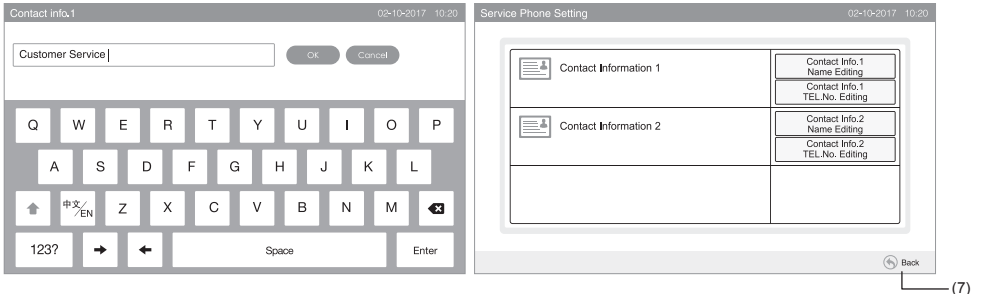

5.9 ALARM HISTORY

The alarm history record of the air conditioner and the central controller.

The time of alarm occurrence, abnormal unit and alarm code are recorded, and the alarm history record deleting is performed by this function.

- 1 Select "Alarm History" on the screen of "Service Menu".
- 2 "Alarm History" screen is indicated.
 - Maximum 160 records can be stored in the memory.
- 3 When deleting alarm history record, touch "Delete History". When touch "OK" at the confirmation screen, all alarm history records are deleted.
 - If touch "Cancel", the screen will be returned to "Alarm History".
- 4 Touch "Back" to finish this setting. The screen is returned to "Service Menu".

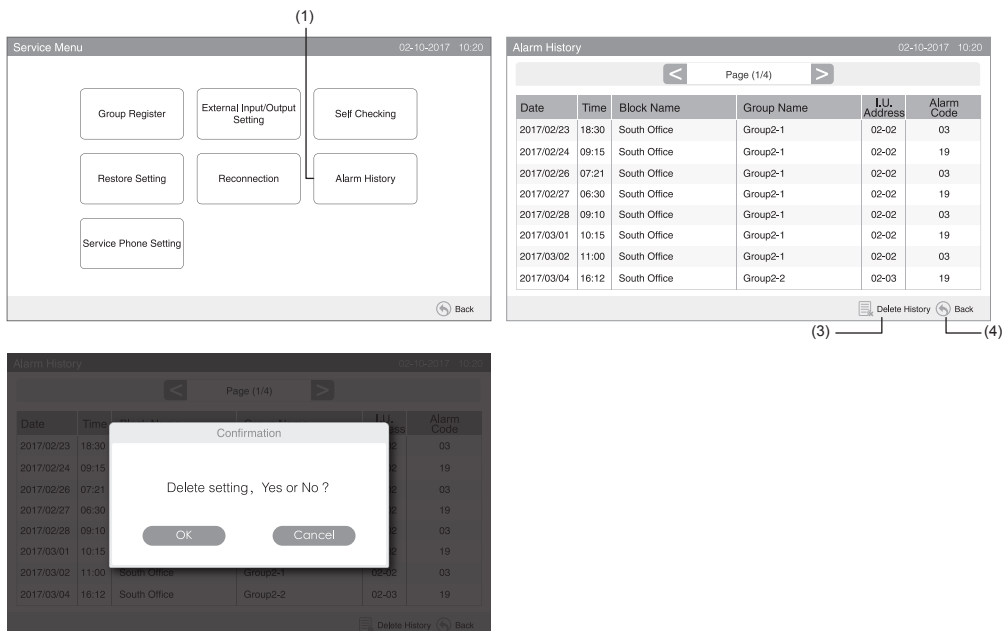

5.10 RESTORE SETTING

1. Select "Restore Setting" on the screen of "Service Menu".



This function cannot be selected when "Remote Operation Prohibited" is set.

2. Touch "OK" at the confirmation screen.



If "Cancel" is tapped, the screen will be returned to "Service Menu".

3. After several seconds, the screen is changed and the connection check of the system is started.

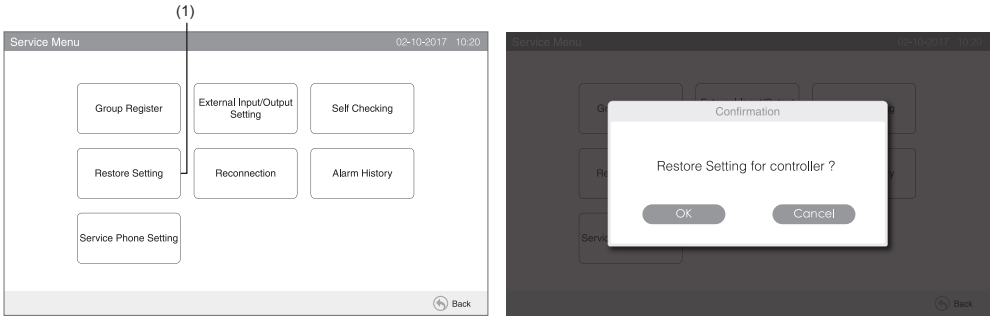

6 OPERATION PROCEDURE

6.1 DISPLAY OF ALL GROUPS

1. Touch “All Groups” on the touchscreen display.

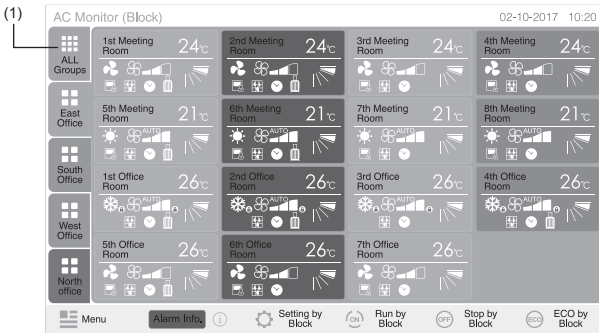

2. All groups are displayed on the touchscreen. (All indoor units connected to the central controller will be indicated). Each operation status is indicated by color of the group button as follows:

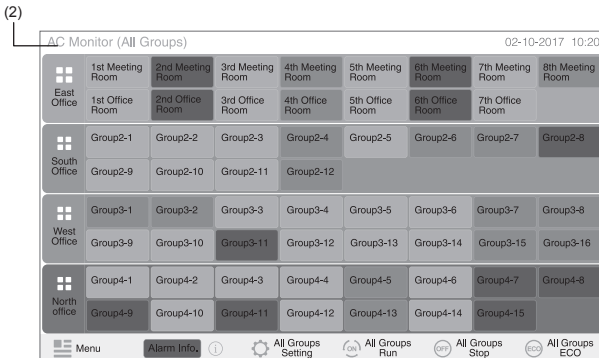

- Green : Run**
- Gray : Stop**
- Red : Abnormal**

i NOTE

The touchscreen display will automatically sleep when the touchscreen is not operated for the given length of time. (To wake up, touch the screen).

6.2 DISPLAY OF SPECIFIED BLOCK

1. Select the target block from the screen of AC Monitor.

AC Monitor (All Groups)

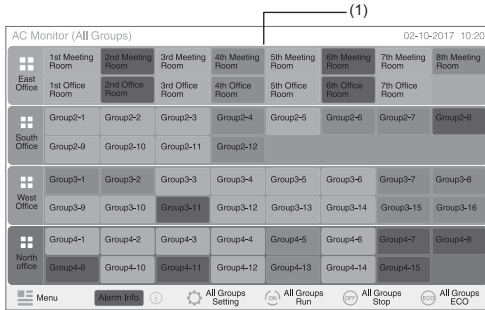

AC Monitor (Block)

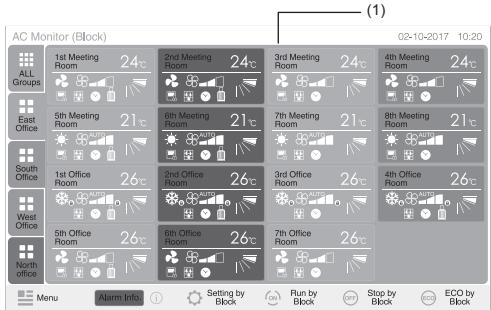

2. The groups in the selected block will be displayed on the touchscreen. Each operation status is indicated by color of the group button as follows:

(2)

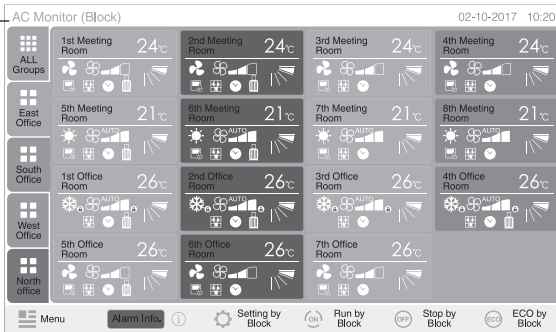

Green : Run

Gray : Stop

Red : Abnormal



NOTE
The touchscreen display will automatically sleep when the touchscreen is not operated for the given length of time. (To wake up, touch the screen.)

6.3 SIMULTANEOUS RUN/STOP/ECO FOR ALL GROUPS

1. Touch "All Groups" on the touchscreen display.
2. Touch "All Groups Run" or "All Groups Stop" or "All Groups ECO".

(1)

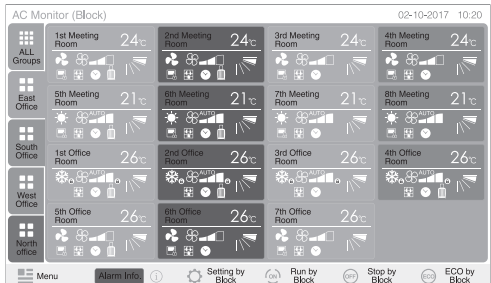
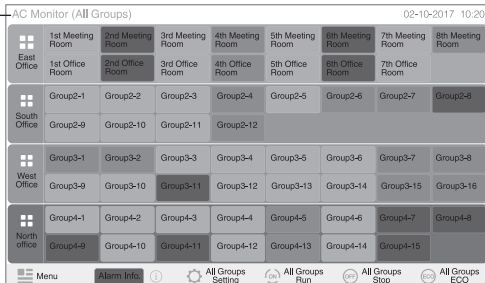

3. The confirmation screen will be displayed. Touch "OK" (All indoor units connected to the central controller will be simultaneously operated) . Touch "Cancel" to cancel this command.

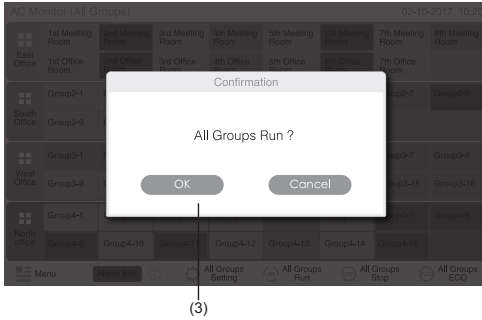

6.4 SIMULTANEOUS RUN/STOP/ECO FOR BLOCK

1. Select the target block from the touchscreen display to set simultaneous Run/Stop/ECO operation.
2. Touch "Run by Block" or "Stop by Block" or "ECO by Block".

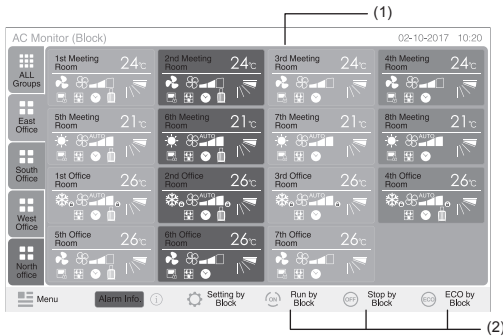

3. The confirmation screen will be indicated. Touch "OK". All groups (all indoor units) in the selected block connected to the central controller will be simultaneously operated. Touch "Cancel" to cancel this command.

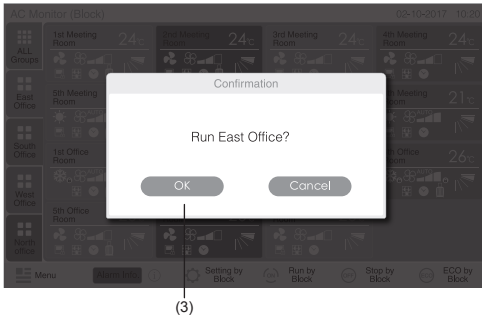

6.5 RUN/STOP FOR EACH GROUP

1. Select the screen of "AC Monitor (All Groups)" or "AC Monitor (Block)". Select the group to set by touching the group button.

AC Monitor (All Groups)

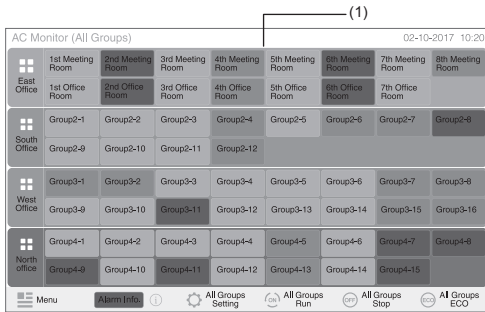

AC Monitor (Block)

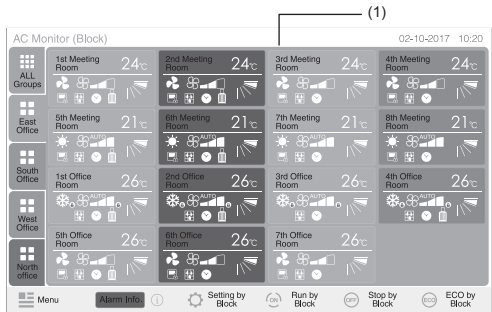

2. Selected group setting will be indicated on the touchscreen display. Touch "RUN" or "STOP".
3. Touch " OK " to confirm and return.
4. Touch " Cancel " to cancel the command and return.

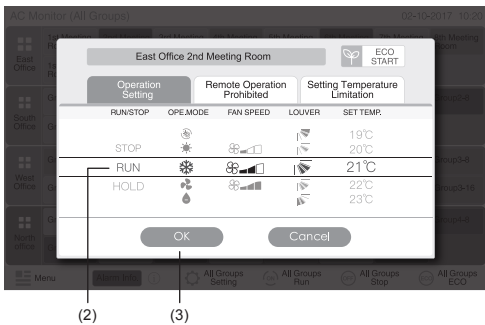

6.6 OPERATION MODE CHANGE

1. Select the screen of "AC Monitor (All Groups)" or "AC Monitor (Block)". Select the group to set by touching the group button.

AC Monitor (All Groups)

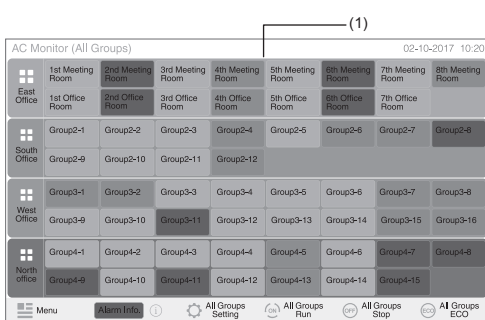

AC Monitor (Block)

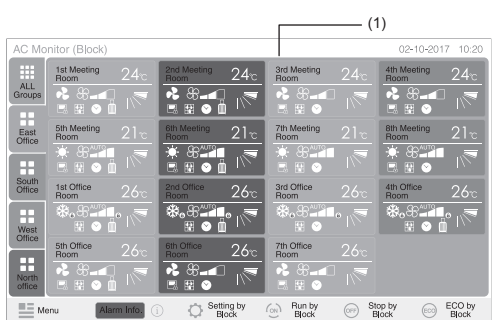

2. Slide the "OPE. MODE", the operation mode will be changed alternately as follows.

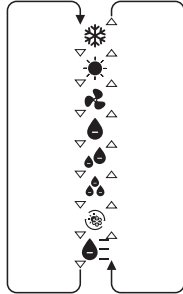

The "AUTO" (Heating/Cooling Automatic Operation) will be included as option if applicable.

3. Touch "OK" to confirm and return.
4. Touch "Cancel" to cancel the command and return.

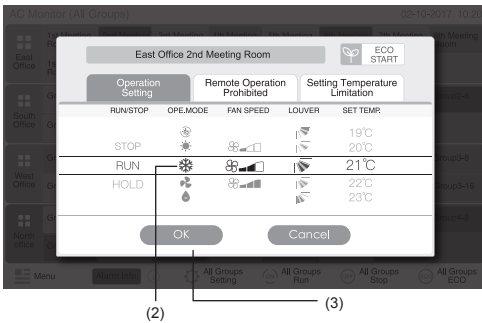

i NOTE

Some operation modes cannot be set depending on the unit model. Contact your dealer for detailed information.

6.7 FAN SPEED SETTING

1. Select the screen of "AC Monitor (All Groups)" or "AC Monitor (Block)". Select the group to set by touching the group button.

AC Monitor (All Groups)

AC Monitor (Block)

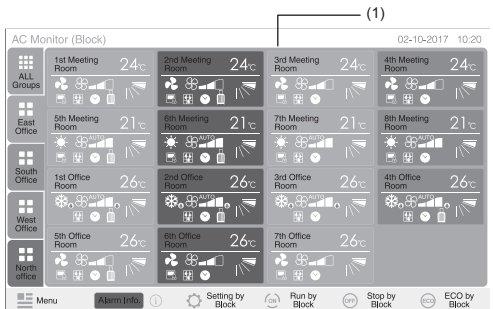
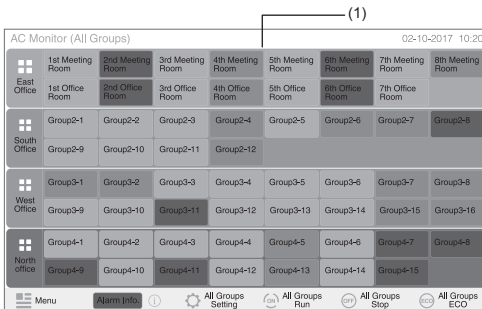

2. Slide the "FAN SPEED", the fan speed setting will be changed alternately as follows.

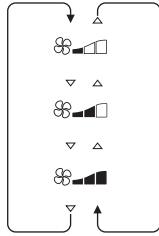

3. Touch "OK" to confirm and return.
4. Touch "Cancel" to cancel the command and return.

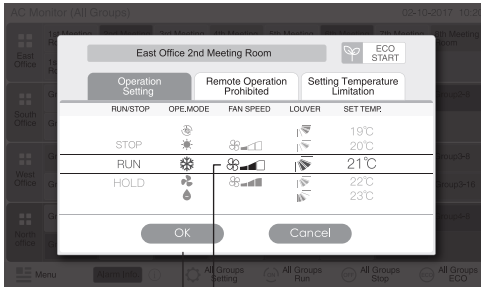

i NOTE

Actual fan speed during the dry operation will be "LOW" regardless of the fan speed setting. The figure above shows an example of standard unit. The fan speed may not be indicated for certain indoor unit model.

6.8 SWING LOUVER DIRECTION

1. Select the screen of "AC Monitor (All Groups)" or "AC Monitor (Block)". Select the group to set by touching the group button.

AC Monitor (All Groups)

AC Monitor (Block)

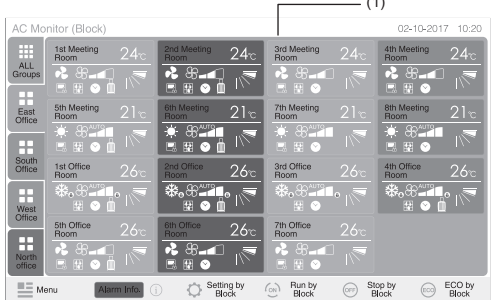
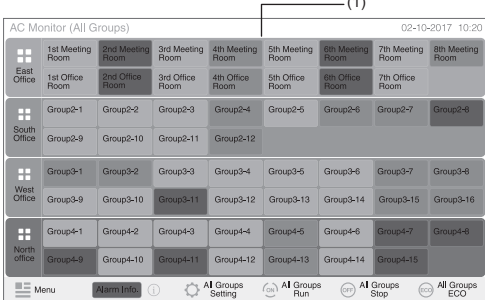

2. Slide the "LOUVER", the swing louver direction will be changed alternately as follows.

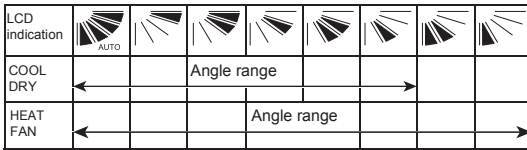

: Auto swing operation will be started.

3. Touch "OK" to confirm and return.
4. Touch "Cancel" to cancel the command and return.

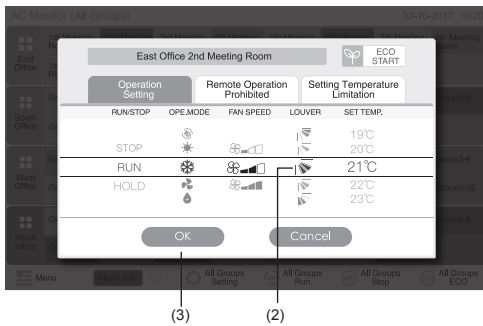

i NOTE

- This function (swing louver direction) may not be set depending on the unit model.
- Louver position on LCD and the actual louver position do not always match during the auto swing operation.
- The louver may not stop immediately after the switch is pressed.

6.9 SETTING TEMPERATURE

1. Select the screen of "AC Monitor (All Groups)" or "AC Monitor (Block)". Select the group to set by touching the group button.

AC Monitor (All Groups)

AC Monitor (Block)

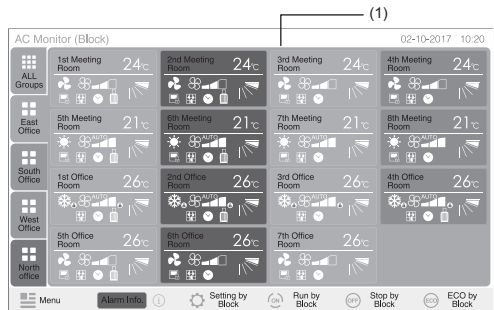
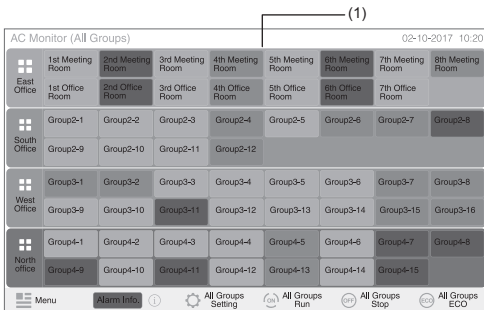

2. Slide up, the temperature is increased by 1°C. (Max. 30°C). Slide down, the temperature is decreased by 1°C.
- At Cooling, Dry and Fan operation: Min. 19°C
 - At Heating operation: Min. 17°C

3. Touch "OK" to confirm and return.
4. Touch "Cancel" to cancel the command and return.

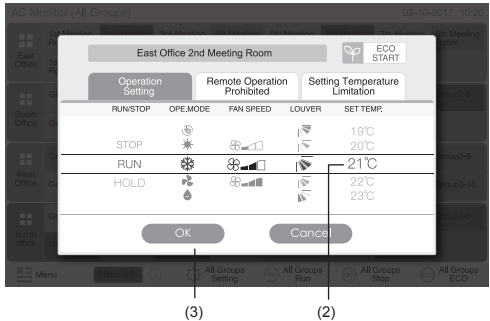

i NOTE

- The figure above shows an example of the setting temperature for the standard unit. The temperature setting range may be different depending on the connected indoor units.

6.10 PERMITTING/PROHIBITING OPERATION FROM REMOTE CONTROL SWITCH

This function is used for prohibiting the operation from the remote control switch. While operation is prohibited, "Central Control" is indicated on LCD of remote control switch and operating by the remote control switch is not available.

1. Select the screen of "AC Monitor (All Groups)" or "AC Monitor (Block)". Select the group to set by touching the group button.

AC Monitor (All Groups)

AC Monitor (Block)

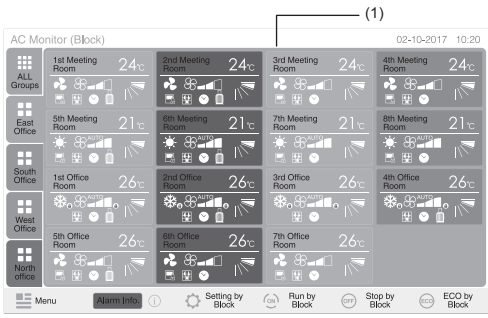
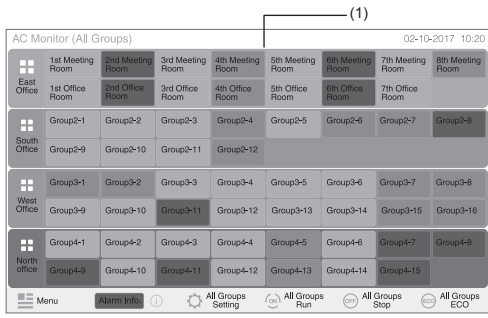

2. Select "Remote Operation Prohibited" by touching.
3. Touch the switch of the items. If "ALL" is ON, the icon "🔒" will be indicated in monitor.
4. Touch "OK" to confirm and return.
5. Touch "Cancel" to cancel the command and return.

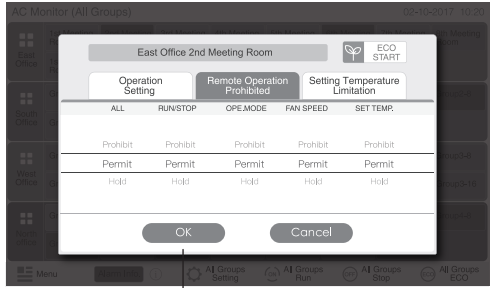
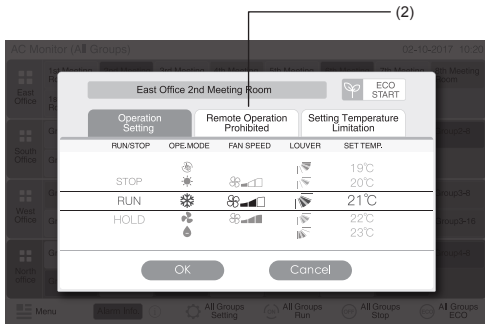

NOTE

- If the unit is started from the central controller it can be stopped from the remote control switch even while the operation from the remote control switch is prohibited. In this case, press "Run" on the remote control switch to start the operation again. However, this method is for an emergency stop therefore do not use this for the normal operation.
- Do not set the prohibiting operation if multiple centralized controllers are used in the same H-NET. Additionally, do not set this by other centralized controller or it may cause malfunction.

6.11 SETTING TEMPERATURE LIMITATION

This function is used to limit the setting temperature from the remote control switch and central controller.

1. Select the screen of "AC Monitor (All Groups)" or "AC Monitor (Block)". Select the group to set by touching the group button.

AC Monitor (All Groups)

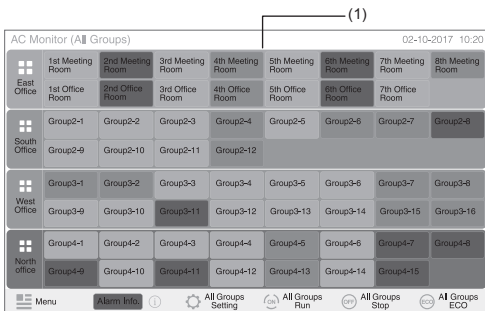

AC Monitor (Block)

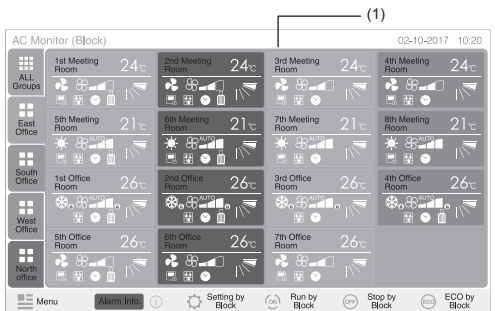

2. Select "Setting Temperature Limitation" by touching.
3. Slide the temperature to set the limitation.
4. Touch "OK" to confirm and return.
5. Touch "Cancel" to cancel the command and return.

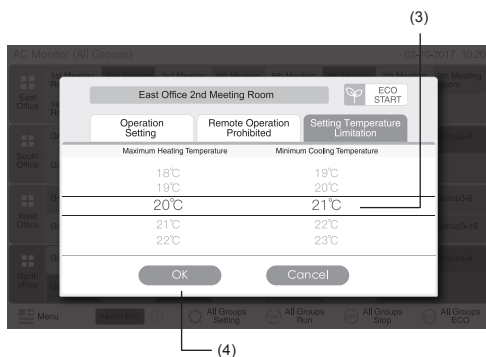
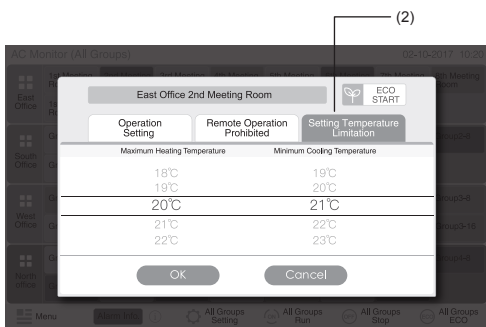

6.12 ECO START

This function is used to operate the indoor unit according to the ECO setting.

1. Select the screen of "AC Monitor (All Groups)" or "AC Monitor (Block)". Select the group to set by touching the group button.

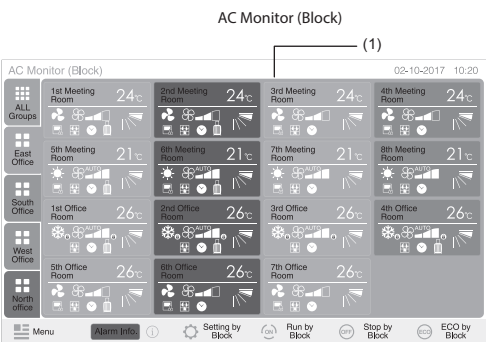
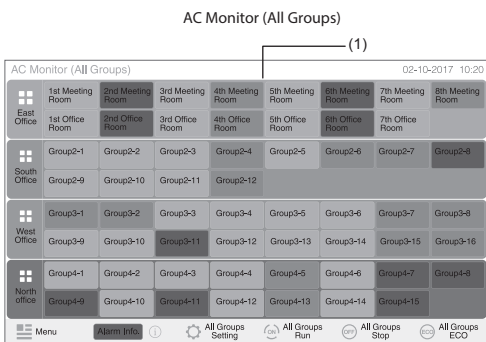

2. Select "ECO START" by touching. ECO function start immediately.

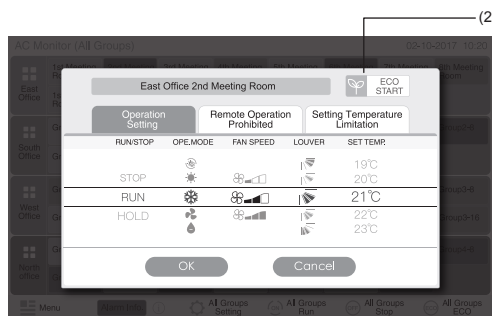

7 MENU

The table below shows menu item and its function.

Item	Function
Filter Sign Reset	This function is used for turning off the filter sign of the connected indoor units. This function can be used only for the indoor unit with "Filter Sign".
Schedule Setting	This function is used for scheduled timer operation which is possible to set by each block or group. This function is used for setting the time (by the minute), "Run/Stop" and temperature (19 ~ 30 °C) .
Schedule Timer Setting	For weekly schedule setting, up to 10 schedule items can be set per day. It is also available to copy the setting contents.
Holiday Setting	This function is used for suspending the schedule operation temporarily. The schedule operation will not be available when this function is set. This function is used for setting irregular holidays such as national holidays.
Schedule Timer ON/OFF Setting	"Schedule Timer OFF Setting" is used for suspending the schedule operation for the target group. The schedule operation will not be available when Schedule Timer is OFF. This function is used for a long holiday.
Date&Time	This function is used for adjusting date and time .
Touchscreen Cleaning	This function is used for cleaning LCD (liquid crystal display) of central controller.
Name Register	This function is used for registering name of the block and group. It is also available to copy the name. If the group/block is registered without name, it will be registered as "Group 1-1" or "Block 1" automatically.
Screen Display Setting	This function is used for setting the screen display.
Brightness	This function is used for adjusting the brightness and auto-off time of the touchscreen display.
Temperature Unit	This function is used for changing the temperature unit.
Accumulated Operation Time	This function is used for indicating the accumulated operation time of the air conditioner. The accumulated operation time will be indicated by month. The operation time is memorized for 24 months.
Contact Information	This function is used for indicating the service contact address and the latest alarm code.
Language Setting	This function is used for changing the displayed language.

7.1 Menu

The setting items for the indoor unit and central controller are laid out in the menu.

1 Touch "Menu" at screen of "AC Monitor (All Groups)" or "AC Monitor (Block)".

AC Monitor (All Groups)



AC Monitor (Block)

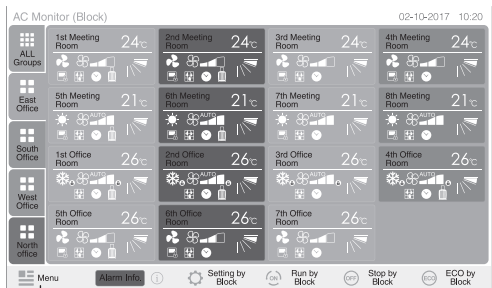

- The screen of "Menu" will be displayed.
- Select the item from the screen of "Menu".

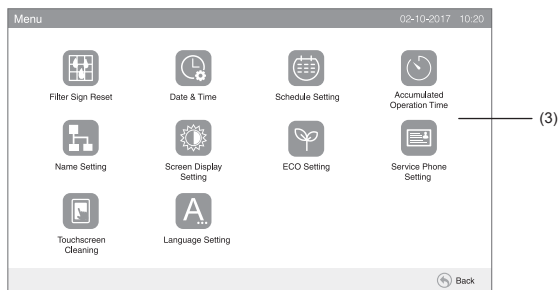

- Touch "Back" to return.

7.2 FILTER SIGN RESET

- Select "Filter Sign Reset" from the screen of "Menu".

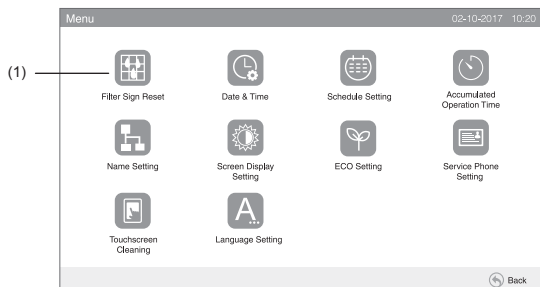

- Select the target (all groups, block or group) to reset the filter sign.

Select "All Groups" or "Block". The following confirmation screen will be indicated. The filter sign can be reset simultaneously by selecting "OK".

When "All Groups" is touched

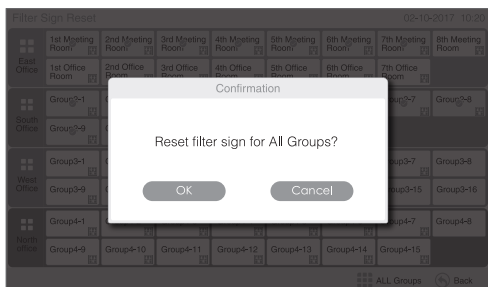

When "Block" is touched



- When the filter sign is reset, filter sign is disappeared.

4. Touch "Back" to return.

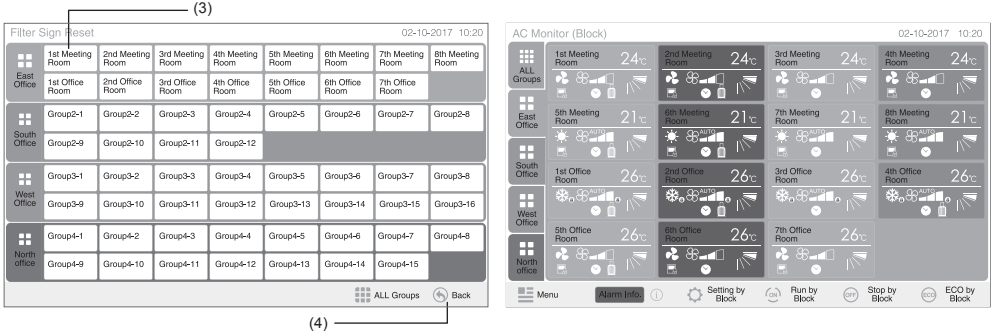

7.3 SCHEDULE OPERATION

7.3.1 GROUP REGISTER

Timer Setting for Weekly Schedule

- 1 Select "Schedule Setting" from the screen of "Menu".
2. Select "Schedule Timer Setting" from the screen of "Schedule Setting".

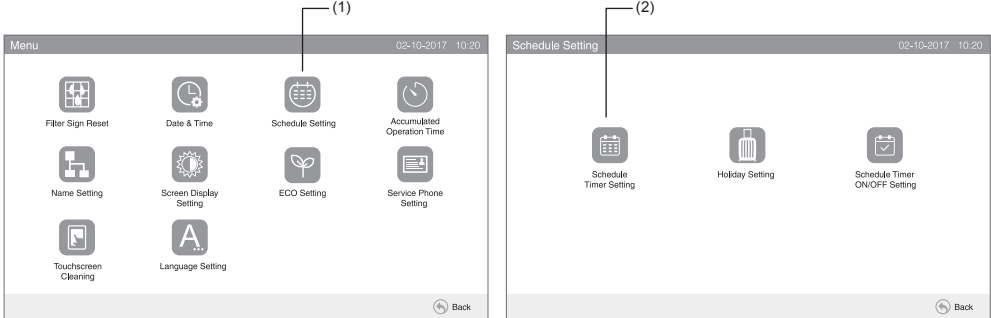

- 3 Select the target (all groups, block or group).
 - The number mark is indicated for the schedule of the group.
- 4 Select the target day of the week (from Mon. to Sun.).
- 5 Select the schedule item number (from 1 to 10).

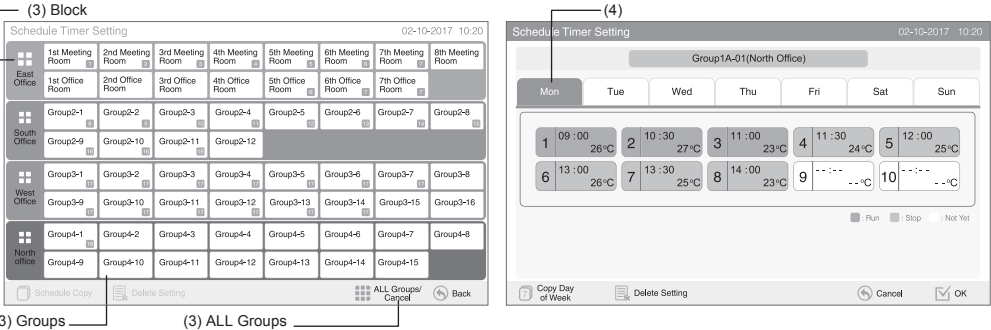

(3) Groups _____ (3) ALL Groups _____

6. Set the schedule time, run/stop operation and temperature.

- Select the schedule item No. (1~10) and set the time.
- Select "RUN" or "STOP".
- Set the temperature.
- "-" will be indicated when the time and temperature are not set.

7. Touch "OK" to register the scheduled items. If "Cancel" is touch, the scheduled items will be canceled.

- To set the same day of the week, refer to the (5).
- To set other days of the week, refer to the (4).

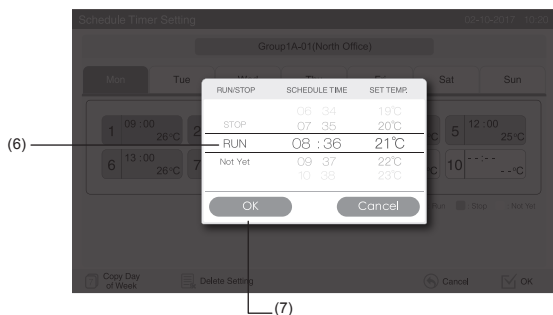

8. Touch "OK" to return and to set the timer for other groups.

9. Touch "Cancel" to cancel the setting set the timer for other groups. The screen will return to "Schedule Timer Setting" (3).

After the schedule is set, the registered schedule number (1 ~ 64) will be indicated in the group button.

In case that the setting is the same, the same registered schedule No. will be indicated.

If "OK" is touched, the screen will be changed to AC Monitor.

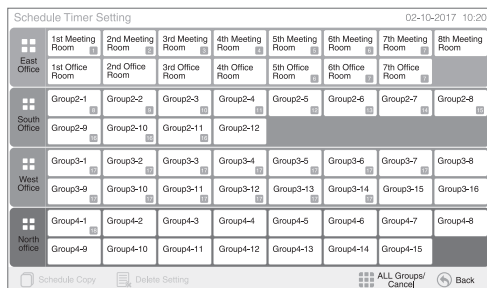
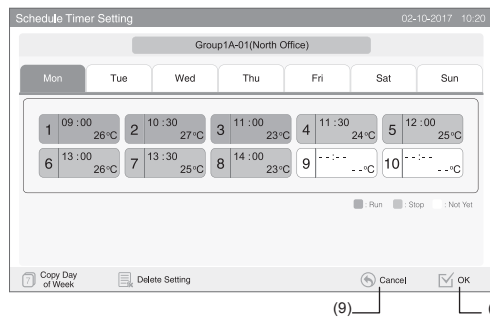

i NOTE

Make sure that the time and run/stop are set for the timer setting. (It is not necessary to set the temperature).

Copying Schedule Setting by Days of Week

- 1 Select "Schedule Setting" from the screen of "Menu".
- 2 Select "Schedule Timer Setting" from the "Schedule Setting".
- 3 Select the target (all groups, block or group).
- 4 Touch "Copy Day of Week".

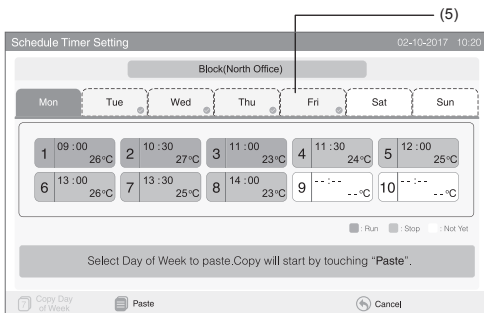
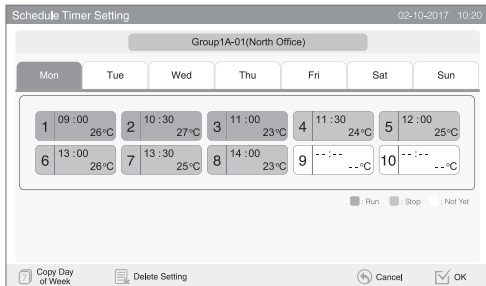

- 5 Select the day of the week tabs to paste.

After the day of the week is selected, the mark of "☑" will be indicated in the day of the week tab. Multiple selection of the days of the week is available to copy. Touch the day of week for reselecting the day of the week tabs.

- 6 Touch "Paste". The schedule setting is copied.

To copy the schedule for other days of the week, refer to the (5).

- 7 If "Cancel" is touched, the copy is canceled.

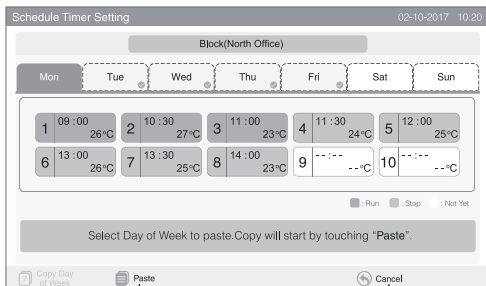

Copying Schedule Setting by Each Group

- 1 Select "Schedule Setting" from the screen of "Menu".
- 2 Select "Schedule Timer Setting" from the screen of "Schedule Setting".
- 3 Select one group to copy. (Block cannot be selected to copy).
- 4 Touch "Schedule Copy".
- 5 Touch "Back" to cancel the copy.

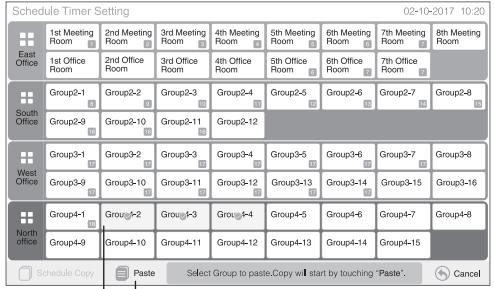
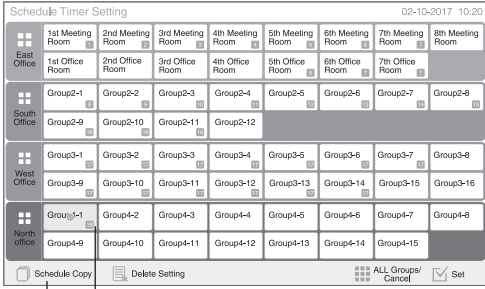

(4) (3)

(6) (7)

- 6 Select the groups to paste.
- 7 Touch "Paste" The schedule setting is copied.
- 8 If "Done" is touched, the screen will return to "Schedule Timer Setting".

Deleting Schedule Setting by day

- 1 Select "Schedule Setting" from the screen of "Menu".
- 2 Select "Schedule Timer Setting" from the screen of "Schedule Setting".
- 3 Select the target (all groups, block or group).
- 4 Select the day for deleting schedule.
- 5 Touch "Delete Setting", the confirmation screen will be displayed.

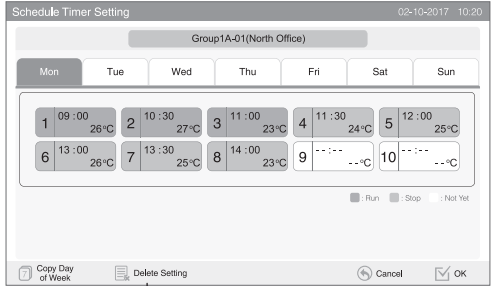
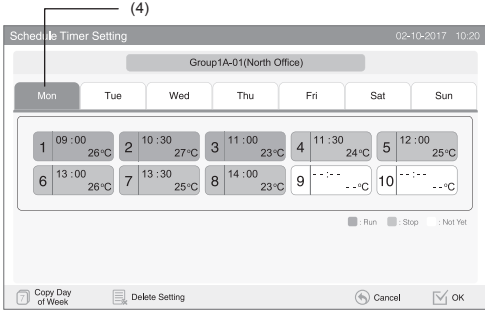

6 If "OK" is touched, the schedule setting will be deleted.

(5)

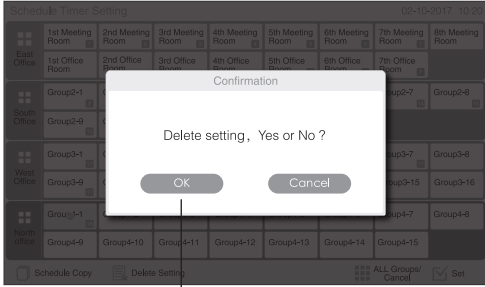

(6)

Deleting Schedule Setting by Each Group

- 1 Select "Schedule Setting" from the screen of "Menu".
- 2 Select "Schedule Timer Setting" from the screen of "Schedule Setting".

3 Select the groups or blocks to delete the setting.

If the groups or blocks are selected, the mark of "☑" is indicated. Multiple selection of group and block are available for deleting.

4 Touch "Delete Setting", the confirmation screen will be displayed.

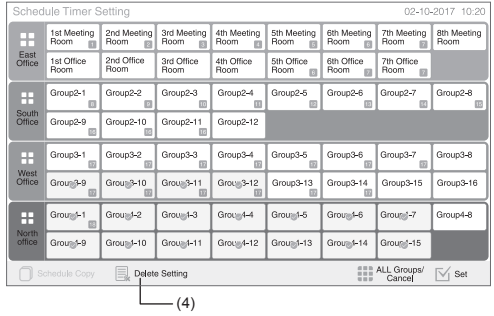
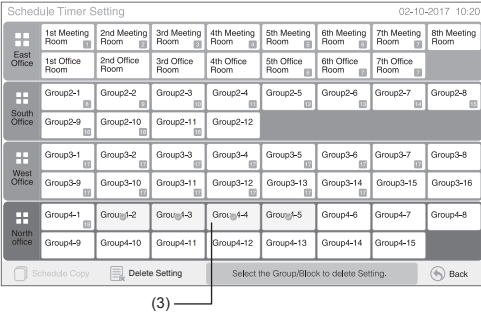

5 If "OK" is touched, the schedule setting will be deleted.

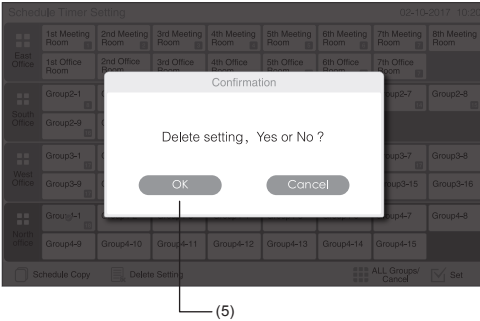

7.3.2 Holiday setting for operation suspended

- 1 Select "Schedule Setting" from the screen of "Menu".
- 2 Select "Holiday Setting" from the screen of "Schedule Setting".

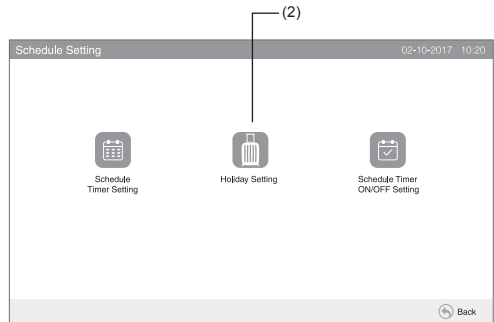
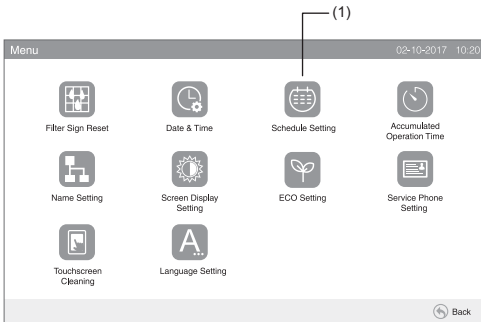

3 Select the target (all groups, block or group). The calendar will be indicated.



"Holiday" means Operation Suspended Day.

4 Set the date to suspend the scheduled operation.

The calendar will be forward/backward by touching “◀” or “▶”.

By touching the date on the calendar, the “Holiday” is set with mark of “☐”. “Holiday Setting” is canceled by touching the same date again. Holiday setting is not available for the days before the present day.

With “All Groups” or “Block” selected, the mark of “☐” will be indicated for the day when the groups with setup holiday and the groups without setup holiday are mixed.

5 Touch “Cancel” to cancel the setting and set the schedule for other groups. The screen will return to “Holiday Setting”.

6 Touch “OK” to confirm the setting and set the schedule for other groups. The screen will return to “Holiday Setting”.

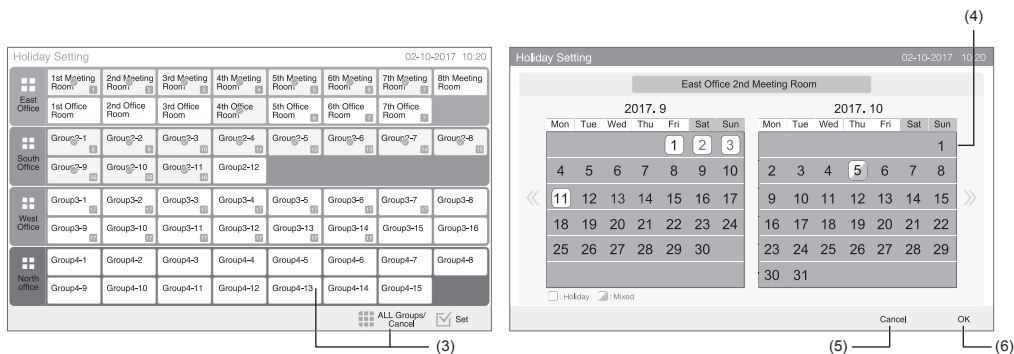

7.3.3 Schedule timer ON/OFF setting

1 Select “Schedule Setting” from the screen of “Menu”.

2 Select “Schedule Timer ON/OFF Setting” from the “Schedule Setting”.

The screen will be changed to the “Schedule Timer ON/OFF Setting”. At first, the setting is “ON” with the mark of “☑”.

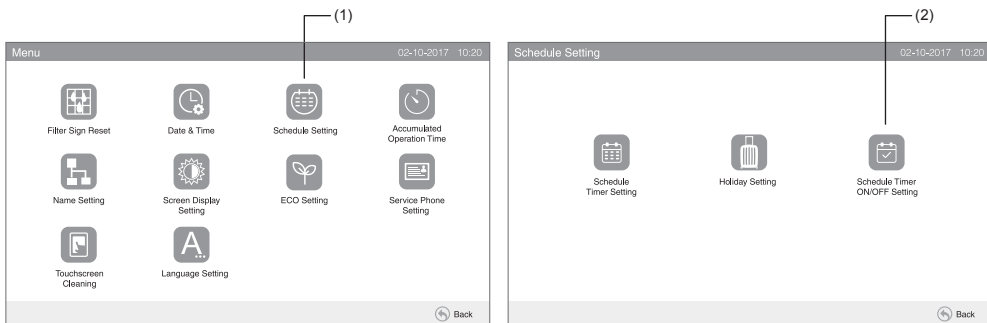

3 Select the target (all groups, blocks or groups).

By touching the button of all groups, blocks or groups, the indication is changed to the “OFF” setting with the mark of “☒”.
By touching the all groups, blocks or groups, the indication is changed alternately in order of “☑” and “☒”.

- Schedule is turned ON: ☑
- Schedule is turned OFF: ☒

4 Touch “OK” to return.

(3) Block

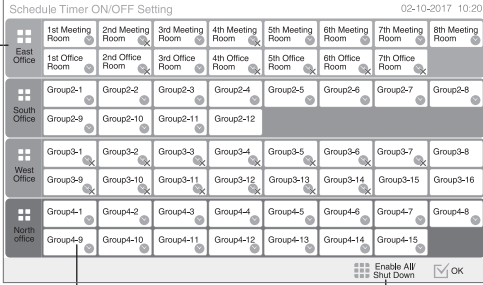

(3) Group

(3) ALL Groups

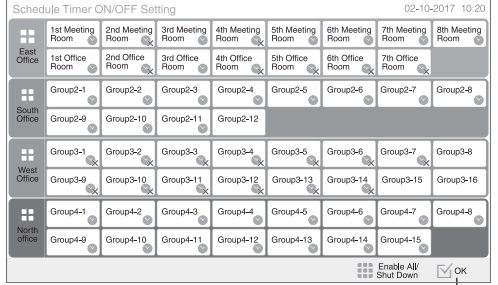

(4)

7.4 DATE&TIME

- 1 Select "Date&Time" from the screen of "Menu".
- 2 Slide the Date and Time to adjust them.
- 3 Touch "OK" to confirm and return.
- 4 Touch "Cancel" to cancel and return.

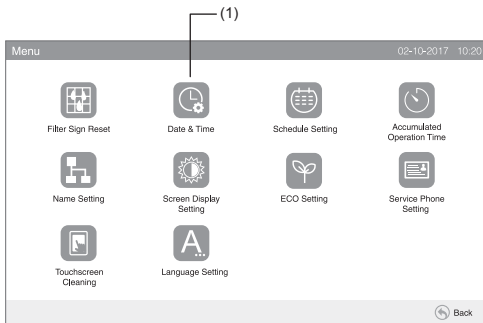

(1)

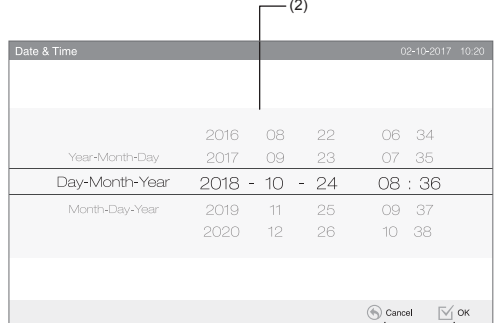

(2)

(4)

(3)

NOTE

- Periodical clock adjustment is recommended. (Clock accuracy: difference +70 sec. per month)
- Adjusting DATE&TIME wrong may clear the accumulated operation time

7.5 TOUCHSCREEN CLEANING

- 1 Select "Touchscreen Cleaning" from the screen of "Menu".
 - 2 The screen will be changed as shown in the figure (2).
- The screen will be locked for 30 seconds. Clean the touchscreen display while the screen is locked.
- 3 It is returned to the screen of AC Monitor automatically.

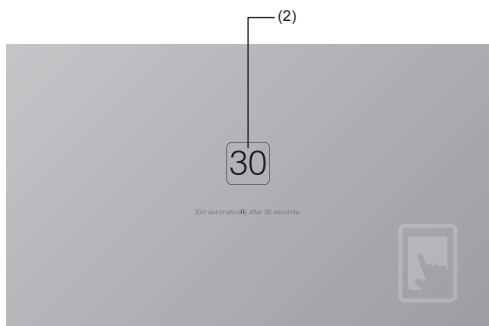
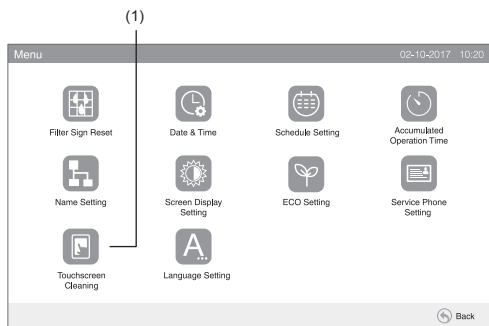

i NOTE

- Clean and wipe the display with dry and soft cloth.
- For oil and fat on the touchscreen such as finger print marks, use diluted neutral detergent. Before cleaning, wring water out to dry. After that, again wipe the display with dry and soft cloth.
- Do not use benzene, thinner or surface active agent in order to protect the touchscreen and body from deformation or deterioration.

7.6 REGISTERING GROUPS/BLOCKS NAME

7.6.1 Registering name of group (Block)

- 1 Select "Name Setting" from the screen of "Menu".
- 2 Select the target (block or group) to set the name.

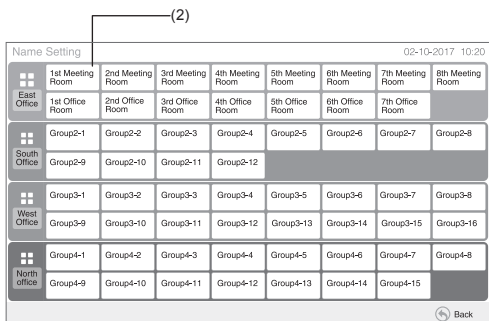
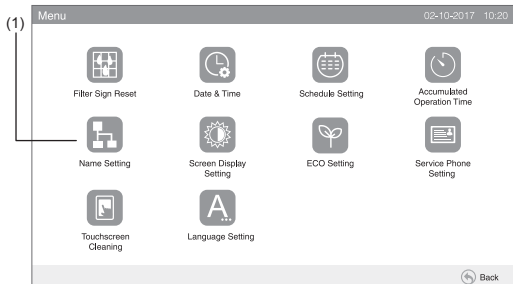

- 3 Enter the group (block) name and touch "OK".
The screen will return to "Name Setting" and entered name is stored.
- 4 Touch "OK" on the screen of (2) to return to the screen of AC Monitor.

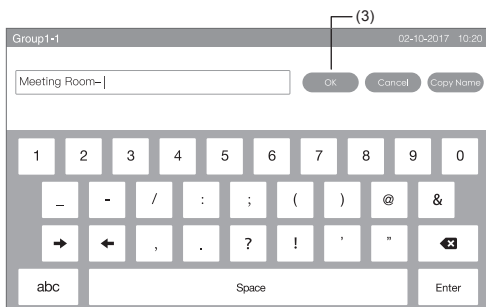

i NOTE

The registrable number of letters are maximum 20 for the name of the group (block). If "ENTER" is pressed, the name is indicated in 2 lines (10 letters/line) on the touchscreen display.

7.6.2 Copying name of group (Block)

- 1 Select "Name Setting" from the screen of "Menu".
- 2 Select one group (block) to copy.
- 3 Touch "Copy Name".

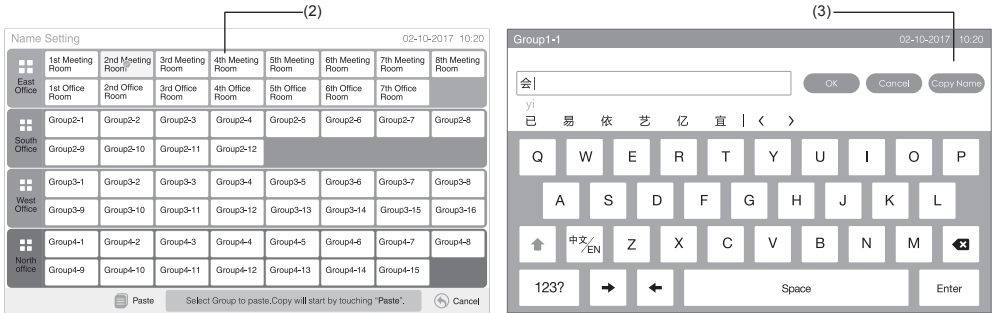

- 4 Select the destination group (block) to paste. The mark of "✔" will be indicated in the button. Multiple selection of group (block) is available to paste. To cancel the selection, press the selected group (block) again, the mark of "✔" will turn off.
- 5 Touch "Paste". The name of the group (block) is copied. To copy the name of other groups, refer to (3). To finish, refer to (6).
- 6 If "Cancel" is tapped without tapping "Paste", the selected items for copying are canceled.

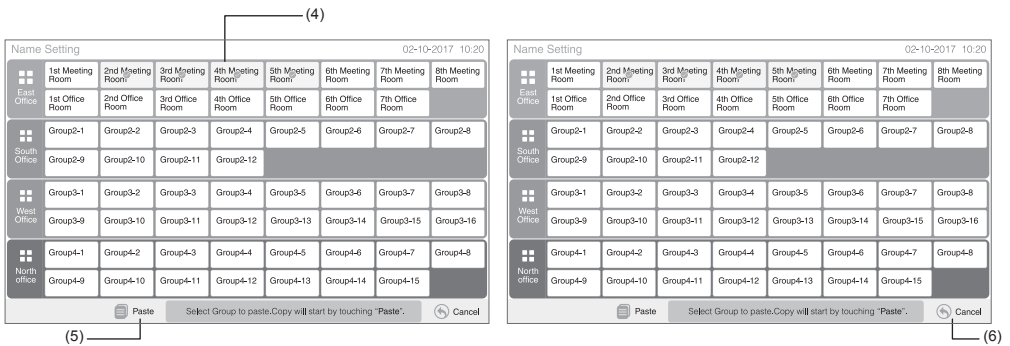

7.7 SCREEN DISPLAY SETTING

7.7.1 Adjusting backlight of touchscreen display

1 Select "Screen Display Setting" from the screen of "Menu".

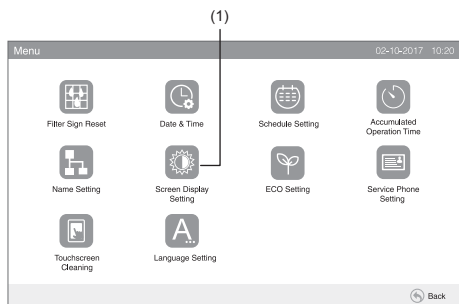

2 Select "Backlight" from the screen of "Screen Display Setting".

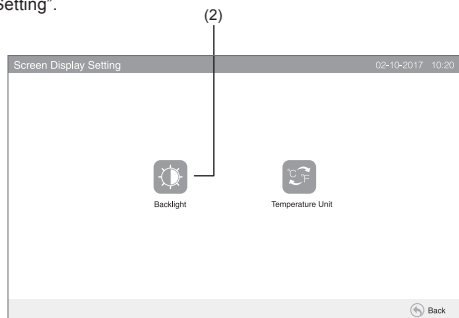

- 3 Slide to adjust the brightness of the backlight.
- 4 Slide to adjust the backlight auto-off.
- 5 Touch "OK" to return to the screen of "Screen Display Setting".

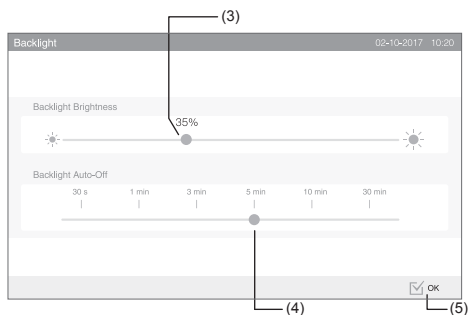

7.7.2 Temperature unit setting

1 Select "Screen Display Setting" from the screen of "Menu".

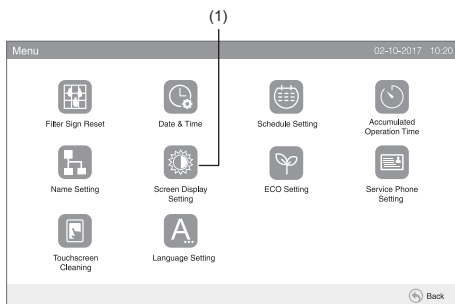

2 Select "Temperature Unit" from the screen of "Screen Display Setting".

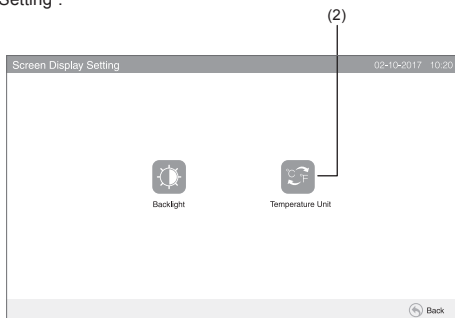

- 3 Select "°C" or "°F" for the operating button indication. The selected button color is changed.
- 4 Touch "OK" to return to the screen of "Screen Display Setting".

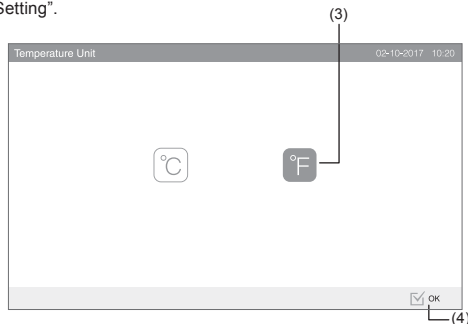

7.8 LANGUAGE SETTING

1. Select "Language Setting" from the screen of "Menu".

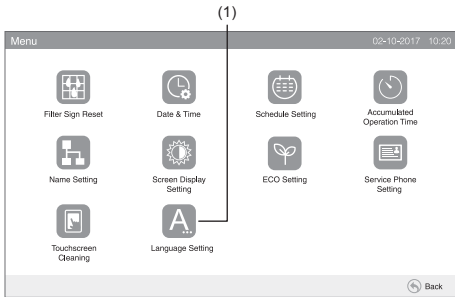

2. The confirmation screen is displayed when selecting the language button.

3. Touch "Done" at the confirmation screen and return to the selected month.

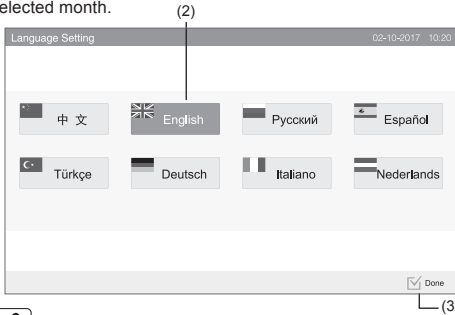

NOTE

If language is changed, the registered block/group name and contact information will not change.

7.9 ACCUMULATED OPERATION TIME OF UNIT

1. Select "Accumulated Operation Time" from the screen of "Menu".

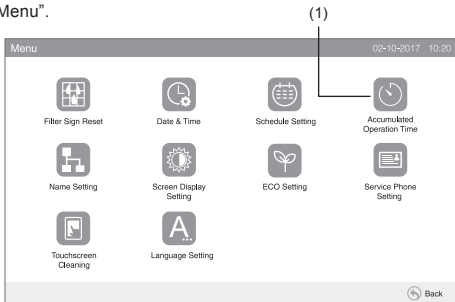

2. Select the target block.

3. Touch "<" or ">" and select the target month. The operation time for the groups in the selected block are indicated according to the selected month.



4. Touch "Export" to output the data of operation time.

5. Touch "Start" to export the "Accumulated Operation Time" to the USB memory stick.

6. Touch "Cancel" to return to "Accumulated Operation Time".

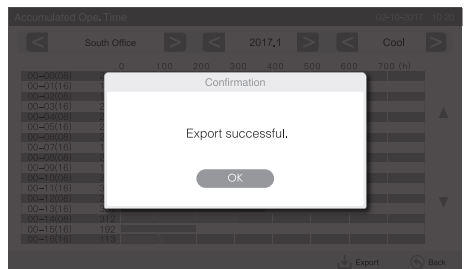
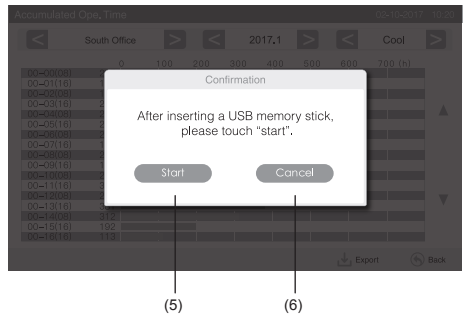

7. Touch "OK" to return to "Accumulated Operation Time", when the exportation is finished.

8. Touch "Back" to return to the screen of AC Monitor.

7.10 CONTACT INFORMATION

1. Select "Service Phone Setting" from the screen of "Menu". The following information will be displayed:

- Contact information
- Block/group name of the latest alarm
- Latest alarm code

2. Touch "Back" to return to the screen of AC Monitor.

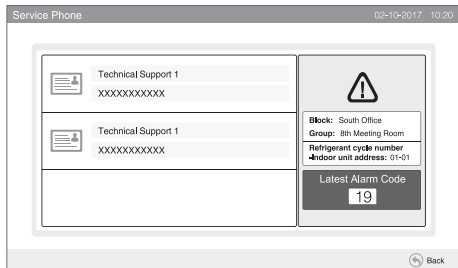
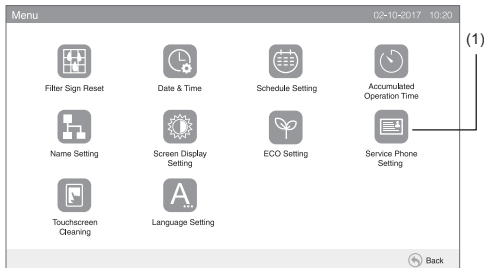

NOTE

Without alarm occurrence, the name of the target block/group and the alarm code will not be indicated.

8. OTHER INDICATIONS ON LCD

8.1 IN NORMAL CONDITION

	Schedule	" " is indicated for the group with the schedule setting
	Remote Operation Prohibited	" " is indicated for the group when operation by remote control switch is prohibited. Operation by remote control switch is not available while operation by remote control switch is prohibited (except for the emergency stop operation).
	Filter Sign	" " is indicated when the air filter of the indoor unit is clogged. After cleaning, press menu and reset the filter sign. The indication will turn off.

8.2 IN ABNORMAL CONDITION

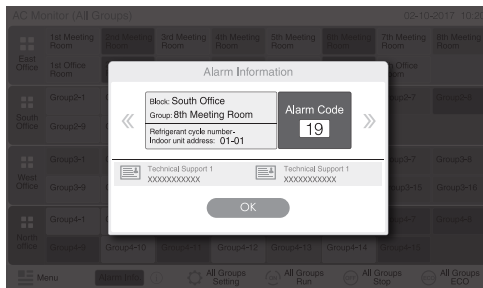

In case that multiple indoor units are in abnormal condition, the details information of abnormality are indicated as above. In that case, the group in abnormal condition can be also selected by touching "«" or "»" on "Alarm" information screen. Check the contents of LCD indication and contact your dealer for details.

Power Failure

- The display is OFF.
- Once the unit is stopped by the power failure, the unit will not start again after the power recovery. Perform the starting procedures again.
- In case of instantaneous power failure within 2 seconds, the unit will automatically start again.

Noise

- There could be a case that the display is OFF. This is caused by the activation of the microcomputer for the unit protection from the electric noise. When the unit is stopped, perform the starting procedures again.

9 TROUBLESHOOTING

Check the following table before contacting a dealer for maintenance.

Condition	Cause
Indications on the touchscreen are not displayed.	Check that the wiring for the power supply is connected to the plug. Check that the power supply is turned ON.
The touchscreen display is slept.	The touchscreen will automatically sleep when the touchscreen is not operated for the given length of time. Touch the screen to wake up.
A part of the touchscreen is not turned on or is constantly turned on.	There may be dead pixel on the LCD. This is not faulty.
The timer operation by the schedule setting does not run.	Check if the holiday setting is turned ON. If so, cancel the holiday setting according to Holiday Setting for Operation Suspended section. Check if the setting of schedule operation is turned OFF. If so, the schedule operation should be turned ON according to Schedule Timer ON/OFF Setting section.
The setting is not changed.	When the central controller connect to so much indoor units, the control speed may drop. This is not faulty.